

53-1002474-01
15 December 2011



Fabric OS FCIP

Administrator's Guide

Supporting Fabric OS v7.0.1

BROCADE

Copyright © 2009-2011 Brocade Communications Systems, Inc. All Rights Reserved.

Brocade, the B-wing symbol, BigIron, DCX, Fabric OS, FastIron, NetIron, SAN Health, ServerIron, and Turbolron are registered trademarks, and Brocade Assurance, Brocade NET Health, Brocade One, CloudPlex, MLX, VCS, VDX, and When the Mission Is Critical, the Network Is Brocade are trademarks of Brocade Communications Systems, Inc., in the United States and/or in other countries. Other brands, products, or service names mentioned are or may be trademarks or service marks of their respective owners.

Notice: This document is for informational purposes only and does not set forth any warranty, expressed or implied, concerning any equipment, equipment feature, or service offered or to be offered by Brocade. Brocade reserves the right to make changes to this document at any time, without notice, and assumes no responsibility for its use. This informational document describes features that may not be currently available. Contact a Brocade sales office for information on feature and product availability. Export of technical data contained in this document may require an export license from the United States government.

The authors and Brocade Communications Systems, Inc. shall have no liability or responsibility to any person or entity with respect to any loss, cost, liability, or damages arising from the information contained in this book or the computer programs that accompany it.

The product described by this document may contain "open source" software covered by the GNU General Public License or other open source license agreements. To find out which open source software is included in Brocade products, view the licensing terms applicable to the open source software, and obtain a copy of the programming source code, please visit <http://www.brocade.com/support/oscd>.

Brocade Communications Systems, Incorporated

Corporate and Latin American Headquarters
Brocade Communications Systems, Inc.
130 Holger Way
San Jose, CA 95134
Tel: 1-408-333-8000
Fax: 1-408-333-8101
E-mail: info@brocade.com

Asia-Pacific Headquarters
Brocade Communications Systems China HK, Ltd.
No. 1 Guanghua Road
Chao Yang District
Units 2718 and 2818
Beijing 100020, China
Tel: +8610 6588 8888
Fax: +8610 6588 9999
E-mail: china-info@brocade.com

European Headquarters
Brocade Communications Switzerland Sàrl
Centre Swissair
Tour B - 4ème étage
29, Route de l'Aéroport
Case Postale 105
CH-1215 Genève 15
Switzerland
Tel: +41 22 799 5640
Fax: +41 22 799 5641
E-mail: emea-info@brocade.com

Asia-Pacific Headquarters
Brocade Communications Systems Co., Ltd. (Shenzhen WFOE)
Citic Plaza
No. 233 Tian He Road North
Unit 1308 - 13th Floor
Guangzhou, China
Tel: +8620 3891 2000
Fax: +8620 3891 2111
E-mail: china-info@brocade.com

Document History

Title	Publication number	Summary of changes	Date
<i>Fabric OS FCIP Administrator's Guide</i>	53-1001349-01	New document.	July 2009
<i>Fabric OS FCIP Administrator's Guide</i>	53-1001349-02	Various changes and corrections.	October 2009
<i>Fabric OS FCIP Administrator's Guide</i>	53-1001755-01	New document for Fabric OS version 6.3.1.	January 2010
<i>Fabric OS FCIP Administrator's Guide</i>	53-1001766-01	New document for Fabric OS version 6.4.0.	March 2010
<i>Fabric OS FCIP Administrator's Guide</i>	53-1002155-01	Updated document for Fabric OS version 7.0.0.	April 2011
<i>Fabric OS FCIP Administrator's Guide</i>	53-1002474-01	Updated document for Fabric OS version 7.0.1.	December 2011

Contents

About This Document

In this chapter	ix
How this document is organized	ix
Supported hardware and software	ix
What's new in this document	x
Document conventions	xi
Text formatting	xi
Command syntax conventions	xi
Notes, cautions, and warnings	xii
Key terms	xii
Notice to the reader	xii
Additional information	xiii
Brocade resources	xiii
Other industry resources	xiii
Getting technical help	xiii
Document feedback	xiv

Chapter 1

FCIP Overview

In this chapter	1
FCIP platforms and supported features	1
FCIP concepts	3
IP WAN network considerations	3

Chapter 2

FCIP on the 7800 Switch and FX8-24 Blade

In this chapter	5
7800 switch hardware overview	6
7800 switch license options	7
VE_Ports and FCIP tunnels on the 7800 switch	8
FCIP trunking capacity on the 7800 switch	8
FX8-24 blade hardware overview	8
Removing FX8-24 blades	10
FX8-24 blade license options	10
VE_Ports and FCIP tunnels on the FX8-24 blade	10
FCIP trunking capacity on the FX8-24 blade	11
10 GbE port considerations	11

FCIP trunking	15
Design for redundancy and fault tolerance	16
FCIP tunnel restrictions for FCP and FICON acceleration features	16
FCIP circuits	16
FCIP circuit failover capabilities	17
Failover in TI zones	20
Bandwidth calculation during failover	20
Adaptive Rate Limiting	21
FSPF link cost calculation when ARL is used	21
QoS SID/DID priorities over an FCIP trunk	21
QoS, DSCP, and VLANs	24
DSCP Quality of Service	24
VLANs and Layer 2 Quality of Service	24
When both DSCP and L2CoS are used	25
DSCP and VLAN support on FCIP circuits	25
Managing the VLAN tag table	26
Compression options	28
IPsec implementation over FCIP tunnels	28
Limitations using IPsec over FCIP tunnels	29
IPsec for the 7800 switch and FX8-24 blade	29
Enabling IPsec and IKE policies	30
Open Systems Tape Pipelining	30
FCIP Fastwrite and OSTP configurations	30
Support for IPv6 addressing	32
IPv6 with embedded IPv4 addresses	33
Configuration preparation	33
Configuration steps	34
Setting VE_Ports to persistently disabled state	34
Configuring VEX_Ports	34
Enabling XISL for VE_Ports	35
Configuring the media type for GbE ports 0 and 1 (7800 switch only)	35
Setting the GbE port operating mode (FX8-24 blade only)	35
Configuring a GbE or XGE port IP address	36
Configuring an IP route	37
Validating IP connectivity	38
Creating an FCIP tunnel	38
Creating additional FCIP circuits	44
Verifying the FCIP tunnel configuration on the Brocade 7800 FX8-24	45
Enabling persistently disabled ports on the Brocade 7800 FX8-24	45
Creating a multicircuit tunnel (example)	46
Modifying an FCIP tunnel on a Brocade 7800 FX8-24 blade	49
Modifying an FCIP circuit on a Brocade 7800 FX8-24 blade	49
Deleting an IP interface on a Brocade 7800 FX8-24 blade	50

Deleting an IP route on a Brocade 7800 FX8-24 blade	50
Deleting an FCIP tunnel on a Brocade 7800 FX8-24 blade	50
Deleting an FCIP circuit on a Brocade 7800 FX8-24 blade	51
Virtual Fabrics and the Brocade 7800 FX8-24 blade	51
Port sharing	51

Chapter 3

FCIP on the FR4-18i Blade

In this chapter	53
FR4-18i blade	54
FR4-18i blade ports	55
FCIP design considerations for the FR4-18i blade	55
Virtual port types	56
Compression on FCIP tunnels	57
Traffic shaping	57
FCIP services license	57
QoS implementation over FCIP	57
DSCP Quality of Service	57
L2CoS Quality of Service	58
When both DSCP and L2CoS are used	58
IPsec implementation over FCIP	58
Limitations using IPsec over FCIP tunnels	59
Configuring IPsec	59
IPsec parameters	60
Creating an IKE and IPsec policy	61
Displaying IKE and IPsec policy settings	61
Deleting an IKE and IPsec policy	61
Viewing IPsec information for an FCIP tunnel	62
Virtual Fabrics and FCIP	62
Options for enhancing tape I/O performance	63
FCIP Fastwrite and OSTP configurations	64
Unsupported configurations for Fastwrite and OSTP	65
FCIP services configuration guidelines	66
Setting persistently disabled ports	67
Configuring VEX_Ports	67
Creating IP interfaces and routes	67
Creating an FCIP tunnel	69
Verifying the FCIP tunnel configuration on the Brocade FR4-18i	69
Enabling persistently disabled ports on the Brocade 7500 FR4-18i70	70
Managing FCIP tunnels	70
Modifying and deleting QoS settings	71
Deleting an FCIP tunnel on a Brocade 7500 FR4-18i	71
Deleting an IP route on a Brocade 7500 FR4-18i	72
Deleting an IP interface on a Brocade 7500 FR4-18i	72

Managing the VLAN tag table.....	72
----------------------------------	----

Chapter 4

FCIP Management and Troubleshooting

In this chapter	73
Inband management	73
IP routing	74
Configuring IP addresses and routes	74
VLAN tagging support	78
IP forwarding support	78
WAN performance analysis tools	80
The tperf option	80
The ipperf option	82
Ippperf performance statistics	83
Starting an ipperf session.....	83
Ippperf options.....	84
Using ping to test a connection.....	84
Using traceroute.....	84
Portshow command usage.....	85
Displaying IP interfaces.....	85
Displaying IP routes.....	85
Displaying FCIP tunnel information.....	85
Displaying IP addresses.....	85
Displaying performance statistics.....	86
Displaying FCIP tunnel information (7800 switch and FX8-24 blade).....	86
Displaying an FCIP tunnel with FCIP circuit information (7800 switch and FX8-24 blade)	86
Displaying FCIP tunnel performance (7800 switch and FX8-24 blade).....	87
Displaying FCIP tunnel TCP connections (7800 switch and FX8-24 blade).....	87
Displaying FCIP circuits (7800 switch and FX8-24 blade)	87
Displaying a single circuit	87
Displaying FCIP circuit performance (7800 switch and FX8-24 blade).....	87
Displaying QoS prioritization for a circuit.....	88
Displaying FCIP tunnel information (FR4-18i blade)	88
FCIP tunnel issues.....	88
FCIP links.....	90
Gathering additional information	90
FTRACE concepts	91

Index

About This Document

In this chapter

- [How this document is organized](#) ix
- [Supported hardware and software](#)..... ix
- [What's new in this document](#)..... x
- [Document conventions](#) xi
- [Notice to the reader](#) xii
- [Additional information](#)..... xiii
- [Getting technical help](#) xiii
- [Document feedback](#) xiv

How this document is organized

- This document is organized to help you find the information that you want as quickly and easily as possible. It contains the following components:
 - [Chapter 1, "FCIP Overview"](#) describes FCIP concepts and features.
 - [Chapter 2, "FCIP on the 7800 Switch and FX8-24 Blade"](#) describes FCIP tunnel and trunking configuration options for the 7800 switch and FX8-24 blade.
 - [Chapter 3, "FCIP on the FR4-18i Blade"](#) describes FCIP tunnel configuration options for the FR4-18i blade.
 - [Chapter 4, "FCIP Management and Troubleshooting"](#) describes FCIP management and troubleshooting operations.

Supported hardware and software

The following hardware platforms support FCIP as described in this manual:

- Brocade DCX, DCX 8510-8, DCX-4S, and DCX 8510-4 with one or more FX8-24 blades
- Brocade 7800 switch
- Brocade DCX and DCX-4S with one or more FR4-18i blades

NOTE

FR4-18i blades are not supported on the 16 Gbps DCX 8510-8 and DCX 8510-4 models.

What's new in this document

Major new additions or deletions in this document support the following:

- Preface. Added location of serial number label for the Brocade 6505 switch.
- Chapter 1
 - Added support for printer emulation in Table 1, “FCIP capabilities by platform,” under the FICON extension row and referenced statement that this is not supported on FR4-18i blades.
 - Added note under “FCIP platforms and supported features” that FCIP connections are not supported between the 7800 switch or FX8-24 blades and previous generation Brocade 7500 switches or FR4-18i blades.
- Chapter 2
 - Under “7800 switch hardware overview,” added the following notes:
 - Copper ports do not support auto-sense functions.
 - With copper media, auto-negotiation must be enabled on the other end of the port connection. 1 Gbps is the only negotiated speed.
 - Under “7800 switch license options” and “FX8-24 blade license options,” added FICON printer emulation to the list of features enabled by the Advanced FICON Acceleration License. Also added printer and other emulation features to the Advanced FICON Acceleration License row of Table 2, “7800 FCIP feature licenses” and Table 3, “FX8-24 blade license options.”
 - Under “VE_Ports and FCIP tunnels on the 7800 switch” and “VE_Ports and FCIP tunnels on the FX8-24 blade” added the following note:
 - VE_Ports or VEX_Ports cannot connect to the same domain at the same time as Fibre Channel E_Ports or EX_Ports.
 - Under “VE_Ports and FCIP tunnels on the 7800 switch” and “VE_Ports and FCIP tunnels on the FX8-24 blade” a note was added concerning VE_Ports.
 - Under “FCIP tunnel restrictions for FCP and FICON acceleration features,” added restrictions about FCIP tunnels not supporting DPS and that both ends of the FICON emulating tunnel must run Fabric OS v7.0 or later if one end of tunnel runs v7.0 or later.
 - Under “FCIP circuit failover capabilities, added “Failover in TI zones” section.
 - Under “Limitations using IPsec over FCIP tunnels,” added limitation that IPsec is not supported on VE group 12-21 on FX8-24 blades and that to enable IPsec with Fabric OS v7.0 and later, both ends of the tunnel must use v7.0 and later.
 - Added timeout value information under the “keep-alive timeout” option.
 - Under “Creating Additional FCIP circuits,” added note about adding additional circuits to an active tunnel when multiple FCIP tunnels are present.
 - Added notes under the “Setting the GbE port operating mode (FX8-24 blade only)” section.
- Chapter 4
 - Under “Inband management,” added that the following functions are not supported by the inband management interface:
 - Downloading firmware
 - IPv6 addressing

Document conventions

This section describes text formatting conventions and important notice formats used in this document.

Text formatting

The narrative-text formatting conventions that are used are as follows:

bold text	Identifies command names Identifies the names of user-manipulated GUI elements Identifies keywords and operands Identifies text to enter at the GUI or CLI
<i>italic text</i>	Provides emphasis Identifies variables Identifies paths and Internet addresses Identifies document titles
<code>code text</code>	Identifies CLI output Identifies command syntax examples

For readability, command names in the narrative portions of this guide are presented in mixed lettercase: for example, **switchShow**. In actual examples, command lettercase is often all lowercase. Otherwise, this manual specifically notes those cases in which a command is case-sensitive.

Command syntax conventions

Command syntax in this manual follows these conventions:

command	Commands are printed in bold.
--option, option	Command options are printed in bold.
-argument, arg	Arguments.
[]	Optional element.
<i>variable</i>	Variables are printed in italics. In the help pages, variables are <u>underlined</u> or enclosed in angled brackets < >.
...	Repeat the previous element, for example “member[:member...]”
value	Fixed values following arguments are printed in plain font. For example, --show WWN
	Boolean. Elements are exclusive. Example: --show -mode egress ingress
\	Backslash. Indicates that the line continues through the line break. For command line input, type the entire line without the backslash.

Notes, cautions, and warnings

The following notices and statements are used in this manual. They are listed below in order of increasing severity of potential hazards.

NOTE

A note provides a tip, guidance, or advice, emphasizes important information, or provides a reference to related information.

ATTENTION

An Attention statement indicates potential damage to hardware or data.



CAUTION

A Caution statement alerts you to situations that can cause damage to hardware, firmware, software, or data.



DANGER

A Danger statement indicates conditions or situations that can be potentially lethal or extremely hazardous to you. Safety labels are also attached directly to products to warn of these conditions or situations.

Key terms

For definitions specific to Brocade and Fibre Channel, see the technical glossaries on MyBrocade. See “[Brocade resources](#)” on page xiii for instructions on accessing MyBrocade.

For definitions of SAN-specific terms, visit the Storage Networking Industry Association online dictionary at:

<http://www.snia.org/education/dictionary>

Notice to the reader

This document may contain references to the trademarks of the following corporations. These trademarks are the properties of their respective companies and corporations.

These references are made for informational purposes only.

Corporation	Referenced Trademarks and Products
Microsoft Corporation	Windows, Windows NT, Internet Explorer

Additional information

This section lists additional Brocade and industry-specific documentation that you might find helpful.

Brocade resources

To get up-to-the-minute information, go to <http://my.brocade.com> and register at no cost for a user ID and password.

For additional Brocade documentation, visit the Brocade SAN Info Center and click the Resource Library location:

<http://www.brocade.com>

Release notes are available on the MyBrocade website and are also bundled with the Fabric OS firmware.

Other industry resources

- White papers, online demos, and data sheets are available through the Brocade website at <http://www.brocade.com/products-solutions/products/index.page>.
- Best practice guides, white papers, data sheets, and other documentation is available through the Brocade Partner website.

For additional resource information, visit the Technical Committee T11 website. This website provides interface standards for high-performance and mass storage applications for Fibre Channel, storage management, and other applications:

<http://www.t11.org>

For information about the Fibre Channel industry, visit the Fibre Channel Industry Association website:

<http://www.fibrechannel.org>

Getting technical help

Contact your switch support supplier for hardware, firmware, and software support, including product repairs and part ordering. To expedite your call, have the following information available:

1. General Information

- Switch model
- Switch operating system version
- Error numbers and messages received
- **supportSave** command output
- Detailed description of the problem, including the switch or fabric behavior immediately following the problem, and specific questions
- Description of any troubleshooting steps already performed and the results

- Serial console and Telnet session logs
- syslog message logs

2. Switch Serial Number

The switch serial number and corresponding bar code are provided on the serial number label, as illustrated below:

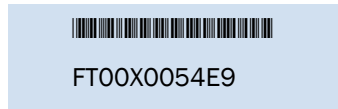

The serial number label is located as follows:

- *Brocade 300, 5100, 5300, 7800, 8000, VA-40FC, 6505, 6510, and Brocade Encryption Switch*—On the switch ID pull-out tab located inside the chassis on the port side on the left
- *Brocade 5410, M5424, 5450, 5460, 5470, 5480*—Serial number label attached to the module
- *DCX 8510-8 and DCX*—On the port side of the chassis, on the lower right side and directly above the cable management comb.
- *DCX 8510-4 and DCX-4S*—On the nonport side of the chassis, on the lower left side.

3. World Wide Name (WWN)

4. Use the **licenseldShow** command to display the switch WWN.

If you cannot use the **licenseldShow** command because the switch is inoperable, you can get the WWN from the same place as the serial number, except for the Brocade DCX and DCX-4S. For the Brocade DCX and DCX-4S, access the numbers on the WWN cards by removing the Brocade logo plate at the top of the non-port side of the chassis.

Document feedback

Quality is our first concern at Brocade and we have made every effort to ensure the accuracy and completeness of this document. However, if you find an error or an omission, or you think that a topic needs further development, we want to hear from you. Forward your feedback to:

documentation@brocade.com

Provide the title and version number of the document and as much detail as possible about your comment, including the topic heading and page number and your suggestions for improvement.

FCIP Overview

In this chapter

- [FCIP platforms and supported features](#) 1
- [FCIP concepts](#) 3
- [IP WAN network considerations](#) 3

FCIP platforms and supported features

There are three Brocade platforms that support FCIP:

- The Brocade 7800 switch
- The Brocade FX8-24 blade (DCX, DCX-4S, DCX 8510-8, and DCX 8510-4 chassis)
- The Brocade FR4-18i blade (DCX, DCX-4S chassis)

NOTE

FCIP connections are not supported between 7800 switch or FX8-24 blades and previous generation Brocade 7500 switches or FR4-18i blades.

Note the following about hardware support:

- The FR4-18i blade is not supported on the 16 Gbps DCX 8510-8, and DCX 8510-4 chassis.
- The FX8-24 and FR4-18i blades are not supported concurrently in the same chassis.
- There are differences in platform capabilities. For example, the FR4-18i blade cannot support FCIP trunking.

[Table 1](#) summarizes FCIP capabilities per platform.

TABLE 1 FCIP capabilities by platform

Capabilities	7800 switch	FX8-24 blade	FR4-18i blade
FCIP trunking	Yes	Yes	No
Adaptive Rate Limiting	Yes	Yes	No
10GbE ports	No	Yes	No
FC ports up to 8 Gbps	Yes (1, 2, 4, 8 Gbps)	Yes (1, 2, 4, 8 Gbps)	No (1, 2, 4 Gbps)
Compression	Yes LZ and Deflate	Yes LZ and Deflate	Yes LZ only

1 FCIP platforms and supported features

TABLE 1 FCIP capabilities by platform (Continued)

Capabilities	7800 switch	FX8-24 blade	FR4-18i blade
Protocol acceleration	Yes	Yes	Yes
<ul style="list-style-type: none"> • FCIP Fastwrite • Open Systems Tape Pipelining <ul style="list-style-type: none"> - OSTP read - OSTP write 			
QoS			
<ul style="list-style-type: none"> • Marking DSCP 	Yes	Yes	Yes
<ul style="list-style-type: none"> • Marking 802.1P - VLAN tagging 	Yes	Yes	Yes
<ul style="list-style-type: none"> • Enforcement 802.1P - VLAN tagging 	Yes	Yes	No
FICON extension	Yes	Yes	Yes
<ul style="list-style-type: none"> • FICON emulation • IBM z/OS Global Mirror (formerly eXtended Remote Copy or XRC) acceleration • Tape read acceleration • Tape write acceleration • Teradata emulation¹ • Printer emulation¹ 			
IPsec	Yes	Yes	Yes
<ul style="list-style-type: none"> • AES encryption algorithm 	Transport mode	Transport mode	Tunnel mode
VEX_Ports	Yes	Yes	Yes
Support for third-party WAN optimization hardware	No ²	No	No ²
IPv6 addresses for FCIP tunnels ³	Yes	Yes	Yes
Support for jumbo frames	No ²	No ²	Yes
	MTU of 1500 is maximum	MTU of 1500 is maximum	

1. This emulation is not supported on the FR4-18i blade.
2. Not supported in Fabric OS version v7.0 and later.
3. IPv6 addressing is not supported in conjunction with IPsec in Fabric OS version v7.0.1.

FCIP concepts

Fibre Channel over IP (FCIP) enables you to use existing IP wide area network (WAN) infrastructure to connect Fibre Channel SANs. FCIP supports applications such as remote data replication (RDR), centralized SAN backup, and data migration over very long distances that are impractical or very costly using native Fibre Channel connections. FCIP tunnels are used to pass Fibre Channel I/O through an IP network. FCIP tunnels are built on a physical connection between two peer switches or blades. Fibre Channel frames enter FCIP through virtual E_Ports (VE_Ports or VEX_Ports) and are encapsulated and passed to Transmission Control Protocol (TCP) layer connections. The TCP connections ensure in-order delivery of FC frames and lossless transmission. The Fibre Channel fabric and all Fibre Channel targets and initiators are unaware of the presence of the IP network. [Figure 1](#) shows the relationship of FC and TCP/IP layers, and the general concept of FCIP tunneling.

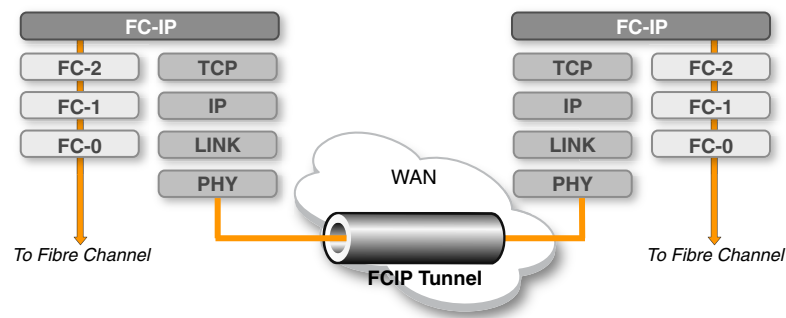

FIGURE 1 FCIP tunnel concept and TCP/IP layers

IP WAN network considerations

Because FCIP uses TCP connections over an existing wide area network, consult with the WAN carrier and IP network administrator to ensure that the network hardware and software equipment operating in the data path can properly support the TCP connections. Keep the following considerations in mind:

- Routers and firewalls that are in the data path must be configured to pass FCIP traffic (TCP port 3225) and IPsec traffic, if IPsec is used (UDP port 500). TCP port 3226 must be configured for the FR4-18i only.
- To enable recovery from a WAN failure or outage, be sure that diverse, redundant network paths are available across the WAN.
- Be sure the underlying WAN infrastructure is capable of supporting the redundancy and performance expected in your implementation.

1 IP WAN network considerations

FCIP on the 7800 Switch and FX8-24 Blade

In this chapter

- 7800 switch hardware overview 6
- 7800 switch license options 7
- FX8-24 blade hardware overview 8
- FX8-24 blade license options 10
- FCIP trunking 15
- Adaptive Rate Limiting 21
- QoS SID/DID priorities over an FCIP trunk 21
- QoS, DSCP, and VLANs 24
- Compression options 28
- IPsec implementation over FCIP tunnels 28
- Open Systems Tape Pipelining 30
- Support for IPv6 addressing 32
- Configuration preparation 33
- Configuration steps 34
- Creating a multicircuit tunnel (example) 46
- Modifying an FCIP tunnel on a Brocade 7800 FX8-24 blade 49
- Modifying an FCIP circuit on a Brocade 7800 FX8-24 blade 49
- Deleting an IP interface on a Brocade 7800 FX8-24 blade 50
- Deleting an IP route on a Brocade 7800 FX8-24 blade 50
- Deleting an FCIP tunnel on a Brocade 7800 FX8-24 blade 50
- Deleting an FCIP circuit on a Brocade 7800 FX8-24 blade 51
- Virtual Fabrics and the Brocade 7800 FX8-24 blade 51

7800 switch hardware overview

Figure 2 shows the FC ports and GbE ports on the 7800 switch. There are 16 FC ports, numbered 0 through 15. The FC ports can operate at 1, 2, 4, or 8 Gbps. There are 6 GbE ports, numbered 0 through 5. Ports 0 and 1 are available as either RJ-45 ports or small form factor pluggable (SFP) transceiver ports. Only six total GbE ports can be used. The 6 GbE ports together can provide up to 6 Gbps total bandwidth.

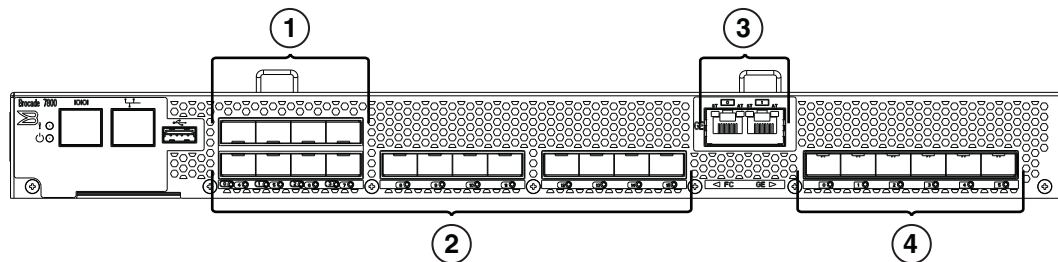

1	FC ports 0 through 3	3	Copper GbE ports 0 and 1 (these ports are RJ-45 copper alternatives for GbE ports 0 and 1.)
2	FC ports 4 through 15	4	GbE ports 0 through 5

FIGURE 2 7800 switch FC and GbE ports

The 7800 switch comes in two models:

- The 7800 4/2 base model uses FC ports 0 through 3, and GbE ports 0 and 1. The GbE ports can be either copper or optical. The RJ-45 copper ports are the default ports. Consider the following when using these ports:
 - Copper ports do not support auto-sense functions.
 - With copper media, auto-negotiation must be enabled on the other end of the port connection. 1 Gbps is the only negotiated speed.
- The 7800 16/6 uses FC ports 0 through 15, and GbE ports 0 through 5. The 7800 upgrade license is required. A 7800 upgrade license can be purchased for a 7800 4/2, which enables 12 more Fibre Channel ports for a total of 16, and enables the use of 4 more optical GbE ports for a total of 6.

7800 switch license options

Some of the capabilities of the Brocade 7800 switch require the following feature license, as described in [Table 2](#).

- The Advanced FICON Acceleration License enables all FICON emulation features:
 - FICON Tape Read Pipelining
 - FICON Tape Write Pipelining
 - FICON IBM z/OS Global Mirror (formerly eXtended Remote Copy or XRC) Emulation
 - FICON Teradata Emulation
 - FICON Printer Emulation
- The Integrated Routing (IR) License is required to configure VEX_Ports to support Fibre Channel Routing (FCR).

TABLE 2 7800 FCIP feature licenses

Feature	Purpose	License (licenseShow output)
7800 upgrade	Enables full hardware capabilities, full FCIP tunnel capabilities, support of advanced capabilities such as open systems tape pipelining (OSTP), FICON CUP support, and separately licensed advanced FICON acceleration feature. ¹	7800 Upgrade license
Advanced FICON acceleration	Enables accelerated tape read/write and IBM z/OS Global Mirror, Teradata, and printer emulation features in FICON environments.	Advanced FICON Acceleration (FTR_AFA) license
Integrated routing (IR)	Required to configure VEX_Ports to support Fibre Channel Routing (FCR).	Integrated Routing license
Advanced Extension License	Required for multiple-circuit tunnels, FCIP trunking, Adaptive Rate Limiting (ARL), and other FCIP features.	Advanced Extension (FTR_AE) license

1. Reboot of 7800 is required after activating the 7800 upgrade license.

Refer to the chapter on administering licensing in the Brocade *Fabric OS Administrator's Guide* for complete information about licensing requirements.

VE_Ports and FCIP tunnels on the 7800 switch

A 7800 switch can support eight VE_Ports. VE_Ports are numbered from 16 through 23. Each FCIP tunnel is identified with a VE_Port number. Up to eight FCIP tunnels can be created. The 7800 switch supports VEX_Ports to avoid the need to merge fabrics.

Consider the following when using tunnels and VE_Ports:

- On a 7800, the total bandwidth limit is 6 Gbps for VE_Ports.
- As a best practice, Fibre Channel traffic through a VE_Port tunnel should not exceed recommended oversubscription guidelines. General guidelines include 2-to-1 oversubscription without compression (for example, 1 Gbps over a 500 Mbps tunnel) and 4-to-1 oversubscription with compression.
- VE_Ports or VEX_Ports cannot connect to the same domain at the same time as Fibre Channel E_Ports or EX_Ports.

FCIP trunking capacity on the 7800 switch

FCIP trunks are built by creating a set of FCIP circuits. FCIP circuits create multiple source and destination addresses for routing traffic over a WAN, providing load leveling and failover capabilities over an FCIP tunnel. When the 7800 upgrade license and Advanced Extension License are activated, the FCIP trunking capacity is as follows:

- The maximum trunk capacity is 6 Gbps.
- You can define up to eight IP addresses for a GbE port.
- There is a hard limit of four FCIP circuits per GbE port, each requiring a unique IP address.
- Up to six FCIP circuits can be defined per FCIP tunnel. These circuits can be spread out over any GbE ports.
- A single FCIP circuit cannot exceed 1 Gbps capacity.

FX8-24 blade hardware overview

[Figure 3](#) on page 9 shows the FC ports, GbE ports, and 10GbE ports on the FX8-24 blade. There are 12 FC ports, numbered 0 through 11. The FC ports can operate at 1, 2, 4, or 8 Gbps. There are 10 GbE ports, numbered 0 through 9. Ports xge0 and xge1 are 10GbE ports.

The FX8-24 blade allows a maximum of 20 Gbps of bandwidth for tunnel connections, and can operate in one of three different modes:

- 1 Gbps mode - You can use all ten GbE ports (0 through 9). Both XGE ports are disabled.
- 10 Gbps mode - You can use the xge0 and xge1 ports.
- Dual mode - You can use GbE ports 0 through 9, and port xge0.

The FX8-24 blade can be deployed in either a DCX, DCX-4S, DCX 8510-8, or DCX 8510-4 chassis.

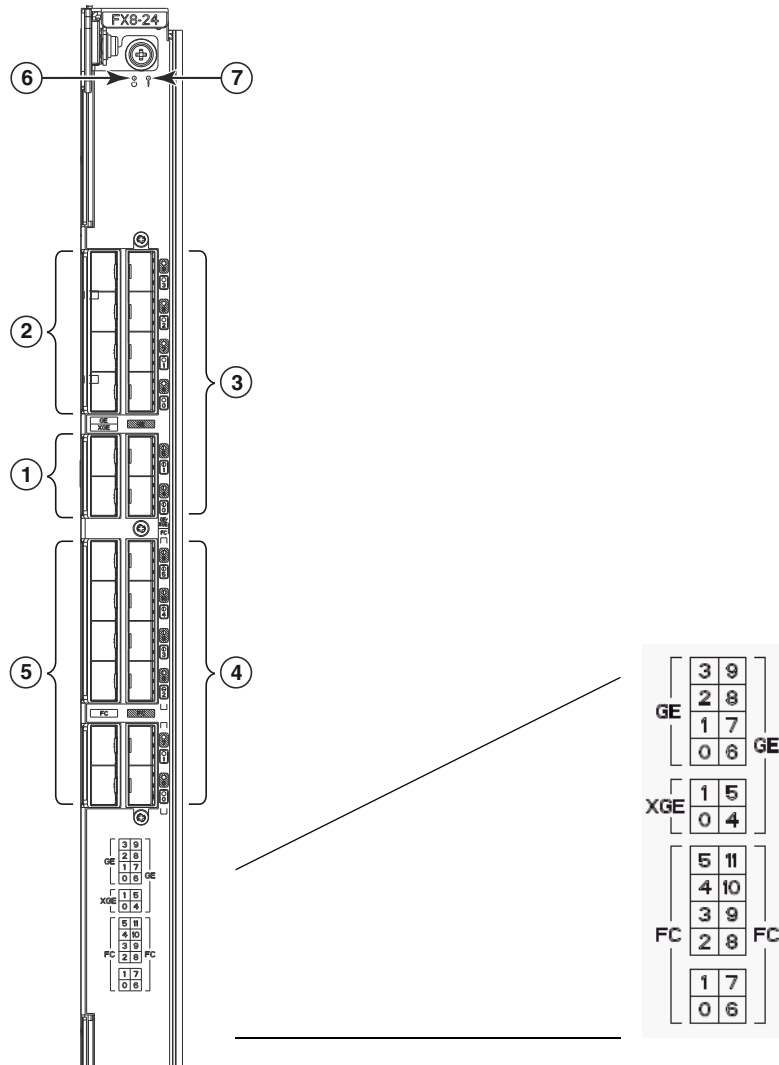

- | | |
|---|--|
| <p>1 10GbE ports (Labeled xge0 and xge1 on the sticker.)</p> <p>2 GbE ports 0 through 3</p> <p>3 GbE ports 4 through 9</p> <p>4 FC ports 6 through 11</p> | <p>5 FC ports 0 through 5</p> <p>6 Power LED</p> <p>7 Status LED</p> |
|---|--|

FIGURE 3 FX8-24 blade FC and GbE ports

Removing FX8-24 blades

ATTENTION

If you are permanently removing a blade from a DCX, DCX-4S, DCX 8510-8, or DCX 8510-4 chassis to relocate to another slot in the chassis or you are removing the blade from the chassis entirely, you must follow these procedures *before removing the blade*.

- Remove all FCIP configuration settings for the blade. If there are residual configuration settings, they may cause issues with future configurations and upgrades.
- Delete the IP addresses assigned to the original slot using the `portcfg ipif delete` command. If this is not done, you must return the FX8-24 blade to the original slot and delete the IP addresses.

FX8-24 blade license options

Some of the capabilities of the FX8-24 blade require the *slot-based* feature licenses shown in [Table 3](#). Use the `licenseshow` command to display license keys and licenses currently installed.

TABLE 3 FX8-24 FCIP feature licenses

Feature	Purpose	License (<code>licenseShow</code> output)
10GbE support	Allows 10 Gbps operation on 10 GbE ports.	10 Gigabit FCIP/Fibre Channel (FTR_10G) license
Advanced FICON acceleration	Enables accelerated tape read/write and IBM z/OS Global Mirror, Teradata, and printer emulation features in FICON environments.	Advanced FICON Acceleration (FTR_AFA) license
Integrated routing (IR)	Required to configure VEX_Ports to support Fibre Channel Routing (FCR).	Integrated Routing license
Advanced Extension License	Required for multiple-circuit tunnels, FCIP trunking, Adaptive Rate Limiting (ARL), and other FCIP features.	Advanced Extension (FTR_AE) license

Refer to the administering licensing chapter in the *Fabric OS Administrator's Guide* for complete information about licensing requirements.

VE_Ports and FCIP tunnels on the FX8-24 blade

An FX8-24 blade can support 20 VE_Ports, and therefore 20 FCIP tunnels. There are two VE_Port groups, numbered 12 through 21 and 22 through 31. Each FCIP tunnel is associated with a specific VE_Port.

VE_Ports do not have to be associated with a particular GbE port on FX8-24 blades and the 7800 switch. VE_Port versus GbE port usage depends on the blade operating mode as follows:

- 1 Gbps mode: VE_Ports 12 through 21 use GbE ports 0 through 9
- Dual mode: VE_Ports 12 through 21 use GbE ports 0 through 9; VE_Ports 22 through 31 use xge0

- 10 Gbps mode: VE_Ports 12 through 21 use xge1; VE_Ports 22 through 31 use xge0

NOTE

In 10 Gbps mode, you can also configure VE_Ports 12 through 21 to use port xge0 as a crossport and VE_Ports 22 through 31 to use port xge1 as a crossport. Refer to [“Crossports”](#) on page 13 for more information.

Considerations for using VE_Ports and FCIP tunnels

Consider the following when using VE_Ports and tunnels:

- Total bandwidth cannot exceed 20 Gbps for VE_Ports.
- As a best practice, Fibre Channel traffic through a VE_Port tunnel should not exceed recommended oversubscription guidelines. General guidelines include 2-to-1 oversubscription without compression (for example, 1 Gbps over a 500 Mbps tunnel) and 4-to-1 oversubscription with compression.
- VE_Ports or VEX_Ports cannot connect to the same domain at the same time as Fibre Channel E_Ports or EX_Ports.

FCIP trunking capacity on the FX8-24 blade

FCIP trunking provides load leveling and failover capabilities through the use of multiple FCIP circuits:

- FCIP tunnels using 1 GbE or 10 GbE ports can have up to ten FCIP circuits spread across any GbE ports.
- You can define up to eight IP addresses (0 through 8 minus the default IPv6 “link-local” address) for a GbE port.
- Up to four FCIP circuits can be configured per 1 GbE port, each requiring a unique IP address.
- Up to ten FCIP circuits can be configured per 10 GbE port, each requiring a unique IP address.
- A single circuit between 1 GbE ports cannot exceed 1 Gbps capacity.

10 GbE port considerations

Enhanced 10GbE port operation is different than 1 GbE port operation and requires special considerations when configuring circuits, tunnels, failover operations, and bandwidth.

Multigigabit circuits

For each 10 GbE port, you can configure multigigabit circuits. For example, a single 10 Gbps circuit or two 5 Gbps circuits can be configured per port. A limit of 10 FCIP circuits can be configured on a single port. The blade at each end of the tunnel must be running Fabric OS v7.0 and later if the committed rate for circuits exceeds 1 Gbps. The maximum committed rate for a circuit between 10 GbE ports is 10 Gbps.

Bandwidth allocation and restrictions

You cannot configure more than 10 Gbps of dedicated bandwidth on a 10GbE port. This includes both primary and secondary circuits. Following are two examples to clarify these requirements.

NOTE

In the following examples, configuring VE_Port 12 on xge0 is a crossport configuration. For more information on crossports, refer to [“Configuring crossports”](#) on page 13.

NOTE

The terms “XGE port” and “GbE port” may be used interchangeably in this document.

- VE_Port 12 has two 10 Gbps circuits. Circuit 0 has a metric of 0 on xge1 and circuit 1 has a metric of 1 on xge0. With this configuration, no other tunnels or circuits would be allowed on this blade because both XGE ports have 10 Gbps of configured bandwidth.
- VE_Port 12 has two 10 Gbps circuits. Circuit 0 has a metric of 0 on xge1, and circuit 1 has a metric of 1 on xge0. In this case, the configuration is allowed, but you could not create additional circuits for either VE port group. For the VE_Port 12-21 port group, VE_Port 12 is consuming 10 Gbps of back end port bandwidth, so additional circuits from another tunnel could not be created. For the VE_Port 22-31 group, the bandwidth would exceed either the front end port bandwidth or the crossport bandwidth. Again VE_Port 12 circuit 1 is consuming 10 Gbps of crossport bandwidth and 10 Gbps of front end port bandwidth for xge0, so you cannot create additional circuits for VE_Port 22-31 group.

Note that there can only be a maximum of 10 Gbps defined over the crossport configuration. Therefore, in the preceding example, since VE_Port 12 is configured with a single 10 Gbps circuit over xge0 (which would be the crossport for VE_Port 12-21 group), there can be no other crossport configurations. You could not configure a crossport for VE_Port 22-31 port group because VE_Port 12 is using all 10 Gbps bandwidth for xge0. This would also restrict you from configuring any circuits for VE_Ports 22-31 at all. Therefore, consuming the crossport bandwidth for primary metric 0 circuits is not recommended. Refer to [“Crossport bandwidth allocation”](#) on page 15 for more information.

Back-end bandwidth

Back-end port bandwidth allocation is calculated as follows:

- Back-end bandwidths are always rounded up to the nearest 1 Gbps. For example, 1.5 Gbps actually consumes 2 Gbps of back-end bandwidth.
- Each VE_Port group is allocated 10 Gbps of back-end bandwidth (10 Gbps for the VE_Port 12-21 group and 10 Gbps for the VE_Port 22-31 group).
- The total back-end port bandwidth allocation is calculated by adding up the consumed bandwidth for each FCIP tunnel in the VE_Port group.
- The consumed bandwidth for a given FCIP tunnel is calculated by adding the maximum committed rates (rounded to the nearest 1 Gbps) for all metric 0 circuits, adding up the maximum committed rates (also rounded to the nearest 1 Gbps) for all metric 1 circuits, then taking the greater of the two values.

Front-end bandwidth

Front-end port bandwidth allocation is calculated as follows:

- Each 10 GbE port is allocated 10 Gbps of front-end bandwidth. The total front-end port bandwidth allocation cannot exceed 10 Gbps per 10 GbE port.
- The total front-end port bandwidth allocation is calculated by adding up the consumed bandwidth for each FCIP tunnel using that XGE port.
- The consumed bandwidth for a given FCIP tunnel is calculated by adding up the maximum committed rates (not rounded) for all metric 0 circuits using that XGE port, adding up the maximum rates (not rounded) for all metric 1 circuits using that XGE port, then taking the greater of the two values.

Crossports

Crossports are addresses and routes that belong to the other 10GbE (XGE) port's DP or VE group. The crossport for xge0 is xge1 and for xge1, the crossport is xge0. To use crossports, the port must be configured in 10 Gbps mode.

NOTE

XGE and GbE port may be used interchangeably in this document.

You can configure IP addresses on crossports, configure a circuit with metrics for circuit failover on crossports, and configure VE_Ports that are normally available on the a local XGE port to operate through a crossport. The crossport is the non-local XGE port for a VE_Port group. In other words, for VE ports 12 through 21, xge1 is the local XGE port and xge0 is the crossport. For VE ports 22 through 31, xge0 is the local XGE port and xge1 is the crossport.

Configuring crossports

Configure crossport XGE port addresses using the **--crossport** or **-x** (shorthand) options for the **portcfg ipif** command, as shown in the following example. Note that in this example, IP address 192.168.11.20, created for a FX8-24 blade in slot 8 on port xge0 will be available for circuits on VE ports 12 through 21.

```
portcfg ipif 8/xge0 create 192.168.11.20 255.255.255.0 1500 --crossport
```

or

```
portcfg ipif 8/xge0 create 192.168.11.20 255.255.255.0 1500 -x
```

Delete the crossport address using the **delete** option instead of the **create** option for the **portcfg ipif** command.

```
portcfg ipif 8/xge0 delete 192.168.11.20 255.255.255.0 1500 -x
```

Configuring 10GbE lossless failover with crossports

Refer to [“10GbE lossless failover”](#) on page 18.

Configuring IP routes with crossports

You can configure IP routes with crossport addresses, as in the following example. In the example, the route will be available for FCIP tunnel circuits using VE ports 12 through 21.

```
portcfg iproute 8/xge0 create 1.1.1.0 255.255.255.0 192.168.11.250 --crossport
```

or

```
portcfg iproute 8/xge0 create 1.1.1.0 255.255.255.0 192.168.11.250 -x
```

Delete the route using the **delete** option instead of the **create** option for the **portcfg iproute** command.

```
portcfg iproute 8/xge0 delete 1.1.1.0 255.255.255.0 -x
```

For more information on configuring an IP route, refer to [“Configuring an IP route”](#) on page 37.

NOTE

If an XGE port has both regular and crossport addresses configured on it, and they use the same IP route, then two routes will need to be configured—a regular route and an identical route on the cross port.

Configuring VLAN tags with crossports

Add entries with crossport addresses to the VLAN tag table, as in the following example. This example allows VE ports 12 through 21 to use the configured local IP interface with this VLAN tag.

```
portcfg vlantag 8/xge0 add 192.168.11.20 200 1 --crossport
```

or

```
portcfg vlantag 8/xge0 add 192.168.11.20 200 1 -x
```

Delete the VLAN tag using the **delete** option instead of the **add** option for the **portcfg vlantag** command.

```
portcfg vlantag 8/xge0 delete 192.168.11.20 200 1 -x
```

NOTE

To tag Class-F traffic or data path traffic, use the **-v**, **-vlan-tagging** option on the **fcipcircuit create** or **fcipcircuit modify** command.

For more information on managing VLAN tags, refer to [“Managing the VLAN tag table”](#) on page 26.

Using ping with crossports

You can ping crossport addresses as in the following example. Note that if the **crossport** or **x** options are not specified and the address is on the crossport, the **portcmd** command will fail with an unknown IP address.

```
portcmd --ping 8/xge0 -s 192.168.11.20 -d 1.1.1.1 --crossport
```

or

```
portcmd --ping 8/xge0 -s 192.168.11.20 -d 1.1.1.1 -x
```

For more information on using ping, refer to [“Using ping to test a connection”](#) on page 84.

Using traceroute with crossports

You can trace a route to a crossport address, as in the following example. Note that if the **crossport** or **x** options are not specified and the address is on the crossport, the **portcmd** command will fail with an unknown IP address.

```
portcmd --traceroute 8/xge0 -s 192.168.11.20 -d 1.1.1.1 -x
```

or

```
portcmd --traceroute 8/xge0 -s 192.168.11.20 -d 1.1.1.1 --crossport
```

For more information on using traceroute, refer to “Using traceroute” on page 84.

Crossport bandwidth allocation

There is a total of 10 Gbps crossport bandwidth allocation for the entire FX8-24 blade. The total crossport bandwidth cannot exceed 10 Gbps for all VE_Ports on the blade. Crossport bandwidth allocation for 10GbE ports is calculated as follows

- The total crossport bandwidth allocation is calculated by adding up the consumed bandwidth for every FCIP tunnel using a crossport IP address.
- The consumed bandwidth for each FCIP tunnel is calculated by adding up the maximum committed rates (not rounded) for all metric 0 circuits that use a crossport IPIF, and then adding up the maximum rates (not rounded) for all metric 1 circuits.

FCIP trunking

FCIP trunking is a method for managing the use of WAN bandwidth and providing redundant paths over the WAN that can protect against transmission loss due to WAN failure. Trunking is enabled by creating logical circuits within an FCIP tunnel. A tunnel can have multiple circuits. You can configure up to 6 circuits on tunnels between 7800 switches and up to 10 on tunnels between FX8-24 blades. Each circuit is a connection between a pair of IP addresses that are associated with source and destination endpoints of an FCIP tunnel, as shown in [Figure 4](#).

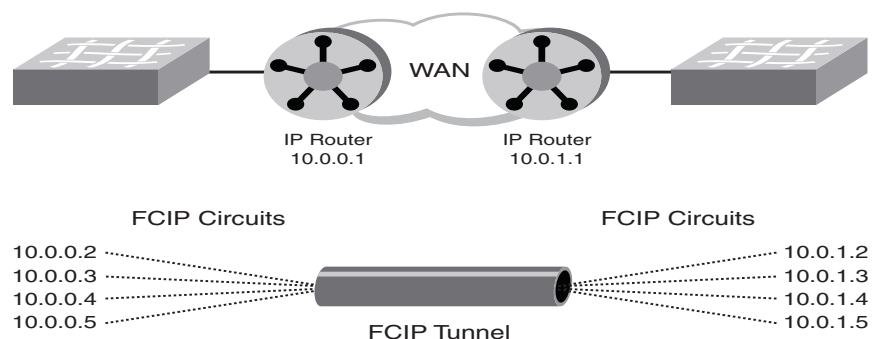

FIGURE 4 FCIP tunnel and FCIP circuits

Design for redundancy and fault tolerance

Multiple FCIP tunnels can be defined between pairs of 7800 switches or FX8-24 blades, but doing so defeats the concept of a multiple circuit FCIP tunnel. Defining two tunnels between a pair of switches or blades is not as redundant or fault tolerant as having multiple circuits in one tunnel.

FCIP tunnel restrictions for FCP and FICON acceleration features

Multiple FCIP tunnels are not supported between pairs of 7800 switches or FX8-24 blades when any of the FICON emulation/acceleration features or FCP acceleration features are enabled on the tunnel, unless TI Zones or LS/LF configurations are used to provide deterministic flows between the switches. These features require deterministic FC Frame routing between all initiators and devices over multiple tunnels. Noncontrolled, parallel (equal-cost) tunnels are not supported between the switch pairs when emulation is enabled on any one or more tunnels without controlling the routing of SID/DID pairs to individual tunnels using TI Zones or LS/LF configurations.

Note these additional restrictions:

- FICON networks with FCIP emulating and nonemulating tunnels do not support DPS (aptpolicy 3) configurations.
- If one end of a FICON emulating tunnel runs Fabric OS v7.0.0 or later, both ends of the tunnel must run Fabric OS v7.0.0 or later.

FCIP circuits

The following list describes FCIP circuit characteristics, restrictions, and usage:

- General tunnel and circuit requirements:
 - A circuit can have a maximum commit rate of 1 Gbps on 1 GbE ports or 10 Gbps on 10 GbE ports.
 - The minimum committed rate allowed on a circuit is 10 Mbps.
 - In a scenario where an FCIP tunnel has multiple circuits of different metrics, circuits with higher metrics are treated as standby circuits and are not used until all lower metric circuits fail. Refer to [“FCIP circuit failover capabilities”](#) for a more detailed description.
 - A circuit defines source and destination IP addresses on either end of an FCIP tunnel.
 - If the circuit source and destination IP addresses are not on the same subnet, an IP static route must be defined that designates the gateway IP address.
 - There are no addressing restrictions for IPv6 and IPv4 when using switches or blades operating with Fabric OS v7.0.0 or later.
 - Committed bandwidth on both sides of the tunnels and circuits must be the same.
 - When load leveling across multiple circuits, the difference between the committed rate of the slowest circuit in the FCIP trunk and the fastest circuit should be no greater than a factor of four (for example, a 100 Mbps and a 400 Mbps circuit will work, but a 10 Mbps and a 400 Mbps circuit will not work). This ensures that the entire bandwidth of the FCIP trunk can be utilized. If you configure circuits with the committed rates that differ by more than a factor of four, the entire bandwidth of the FCIP trunk cannot be fully utilized.

- Tunnel and circuit requirements for 7800 extension switches:
 - You can define up to eight IP addresses for a GbE port.
 - The 7800 switch contains up to six GbE ports. You can configure up to six circuits per tunnel spread out over any of these ports.
 - Total circuits per switch cannot exceed 24 (total of four circuits for all GbE ports).
 - Each circuit requires a unique IP address.
 - A single FCIP circuit cannot exceed 1 Gbps capacity.
- Tunnel and circuit requirements for FX8-24 extension blades:
 - You can define up to eight IP addresses for a GbE port.
 - You can configure up to ten circuits for an FCIP tunnel.
 - The FX8-24 blade contains two 10GbE ports. You can define up to ten circuits per FCIP tunnel spread across the 10GbE ports.
 - The FX8-24 blade contains ten 1GbE ports. You can define up to ten circuits per FCIP tunnel spread across the 1GbE ports.
 - A limit of four FCIP circuits can be configured on a single 1 GbE port.
 - A limit of ten FCIP circuits can be configured on a single 10 GbE port.
 - A limit of twenty FCIP circuits can be configured per VE port group (12 through 21 or 22 through 31) when using a 10G port. For the twenty circuits, ten are configured on local ports and ten on crossports
 - For a FX8-24 blade with a VE_Port group on a 10GbE port, the sum of the maximum committed rates of that group's primary circuits cannot exceed 10 Gbps. This same limit applies to secondary circuits.

NOTE

For any FCIP circuit going over the 10GbE ports, the back-end limit is rounded to the nearest 1 Gbps increments for each VE_Port group. As an example, a circuit defined as 1.5 Gbps is actually going to consume 2 Gbps of back-end bandwidth.

- For Adaptive Rate Limiting (ARL), you can configure a maximum rate of 10 Gbps combined for all tunnels over a single 10 GbE port and 10 Gbps for any single circuit.

FCIP circuit failover capabilities

Each FCIP circuit is assigned a metric, either 0 or 1, which is used in managing failover for FC traffic. If a circuit fails, FCIP trunking first tries to retransmit any pending send traffic over another lowest metric circuit. In [Figure 5](#) on page 18, circuit 1 and circuit 2 are both lowest metric circuits. Circuit 1 has failed, and transmission fails over to circuit 2, which has the same metric. Traffic that was pending at the time of failure is retransmitted over circuit 2. In-order delivery is ensured by the receiving 7800 switch.

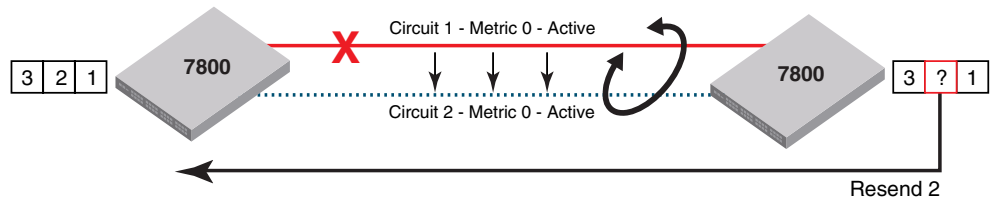

FIGURE 5 Link loss and retransmission over peer lowest metric circuit

NOTE

Modifying a circuit metric disrupts traffic.

In Figure 6, circuit 1 is assigned a metric of 0, and circuit 2 is assigned a metric of 1. Both circuits are in the same FCIP tunnel. In this case, circuit 2 is a standby that is not used unless there are no lowest metric circuits available. If all lowest metric circuits fail, then the pending send traffic is retransmitted over any available circuits with the higher metric. Failover between like metric circuits or between different metric circuits is lossless.

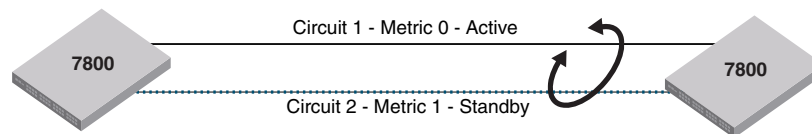

FIGURE 6 Failover to a higher metric standby circuit

10GbE lossless failover

Circuit failover is supported between 10GbE circuits on FX8-24 blades when both 10GbE ports are on the same logical switch and are operating in 10 Gbps mode. Besides configuring secondary circuits for failover, you can configure a set of IP addresses for circuit failover on crossports. Crossports are addresses (and routes) that belong to the other 10GbE port’s DP or VE group. In other words, the crossport for xge0 is xge1 and for xge1, the crossport is xge0. For more information on crossports and configuring crossports, refer to “Crossports” on page 13.

The benefits of 10GbE lossless failover include the following:

- Provides failover to protect against link or network failure and 10GbE port disable.
- Data will not be lost due to failover.
- Failover supports active-passive and active-active configurations.
- Supported in 10 Gbps mode only.

- Dual mode (10 Gbps and 1 Gbps) is not supported for 10GbE failover.
- Failover does not protect against Data Path (DP) complex failure.
- Disabling a VE_Port will not trigger 10GbE lossless failover. In this case, route failover will occur if there is another route available, and may cause loss of frames.

There are two types of configuration supported:

- Active-active – Data will be sent on both 10GbE ports, thus balancing the load across the ports.
- Active-passive – Data fails over to a passive circuit (one with a higher metric) if all active circuit paths fail.

You must establish a metric for failover circuits. If no metric is provided, circuit data will be sent through both ports and the load will be balanced. Circuits using the crossport interface use the default metric of 0. A metric of 1 is required for a standby circuit.

Active-active configuration

The following examples shows an active-active configuration in which two circuits are configured with the same metric, one circuit going over xge0 and the other circuit going over the crossport using xge1 as the external port (for more information on configuring crossports, refer to [“Crossports”](#) on page 13). The metric values of both the circuits are the same (default value), so both circuits send data. The load is balanced across these circuits. Effective bandwidth of the tunnel in this example is 2 Gbps.

1. Configure an IP address on interface xge0.

```
portcfg ipif 8/xge0 create 192.168.11.20 255.255.255.0 1500
```

2. Configure an IP address on crossport interface xge1.

```
portcfg ipif 8/xge1 create 192.168.10.10 255.255.255.0 1500 -x
```

3. Create a tunnel with one circuit going over xge0.

```
portcfg fcipunnel 8/22 create 192.168.11.20 192.168.11.21 1000000
```

4. Add another circuit, going over crossport xge1, to the tunnel.

```
portcfg fcipcircuit 8/22 create 1 192.168.10.10 192.168.10.11 1000000
```

NOTE

If the source and destination addresses are on different subnets, you must configure IP routes for the crossport addresses. Refer to [“Configuring IP routes with crossports”](#) on page 14.

Active-passive configuration

The following example shows an active-passive configuration in which two circuits are configured with the different metrics, one circuit going over xge0 and the other circuit going over the crossport using xge1 as the external port. In this example, circuit 1 is a failover circuit because it has a higher metric. When circuit 0 goes down, the traffic is failed over to circuit 1. Effective bandwidth of the tunnel in this example is 1 Gbps

1. Configure an IP address on interface xge0.

```
portcfg ipif 8/xge0 create 192.168.11.20 255.255.255.0 1500
```

2. Configure an IP address on crossport interface xge1.

```
portcfg ipif 8/xge1 create 192.168.10.10 255.255.255.0 1500 -x
```

3. Create a tunnel with one circuit going over xge0.

```
portcfg fciptunnel 8/22 create 192.168.11.20 192.168.11.21 1000000 --metric 0
```

4. Add another circuit, going over crossport xge1, to the tunnel.

```
portcfg fcipcircuit 8/22 create 1 192.168.10.10 192.168.10.11 1000000 --metric 1
```

NOTE

If the source and destination addresses are on different subnets, you must configure IP routes for the crossport addresses. Refer to [“Configuring IP routes with crossports”](#) on page 14.

Failover in TI zones

In Traffic Isolation (TI) zone configurations with failover enabled, non-TI zone traffic will use the dedicated path if no other E_Port or VE_Port paths exist through the fabric or if the non-dedicated paths are not the shortest paths. Note that a higher bandwidth tunnel with multiple circuits will become the shortest path compared to a tunnel with one circuit.

Bandwidth calculation during failover

The bandwidth of higher metric circuits is not calculated as available bandwidth on an FCIP tunnel until all lowest metric circuits have failed. Following is an example.

Assume the following configurations for circuits 0 through 3:

- Circuits 0 and 1 are created with a metric of 0. Circuit 0 is created with a maximum transmission rate of 1 Gbps, and circuit 1 is created with a maximum transmission rate of 500 Mbps. Together, circuits 0 and 1 provide an available bandwidth of 1.5 Gbps.
- Circuits 2 and 3 are created with a metric of 1. Both are created with a maximum transmission rate of 1 Gbps, for a total of 2 Gbps. This bandwidth is held in reserve.

The following actions occur during circuit failures:

- If either circuit 0 or circuit 1 fails, traffic flows over the remaining circuit while the failed circuit is being recovered. The available bandwidth is still considered to be 1.5 Gbps.
- If both circuit 0 and circuit 1 fail, there is a failover to circuits 2 and 3, and the available bandwidth is updated as 2 Gbps.
- If a low metric circuit becomes available again, the high metric circuits go back to standby status, and the available bandwidth is updated again as each circuit comes online. For example, if circuit 0 is recovered, the available bandwidth is updated as 1 Gbps. If circuit 1 is also recovered, the available bandwidth is updated as 1.5 Gbps.

Adaptive Rate Limiting

Adaptive Rate Limiting (ARL) is performed on FCIP circuits to change the rate in which the FCIP tunnel transmits data through the IP network. ARL uses information from the TCP connections to determine and adjust the rate limit for the FCIP circuit dynamically. This allows FCIP connections to utilize the maximum available bandwidth while providing a minimum bandwidth guarantee. ARL is configured on a per-circuit basis because each circuit may have available differing amounts of bandwidth.

ARL applies a minimum and maximum traffic rate, and allows the traffic demand and WAN connection quality to dynamically determine the rate. If traffic is flowing error-free over the WAN, the rate grows towards the maximum rate. If TCP reports an increase in retransmissions, the rate reduces towards the minimum. ARL never attempts to exceed the maximum configured value and reserves at least the minimum configured value. The aggregate of the minimum configured values cannot exceed the speed of the Ethernet interface, which is 1 Gbps for GbE ports or 10 Gbps for 10GbE ports.

The maximum configured committed rate can be no larger than five times the minimum committed rate.

For Fabric OS v7.0.0 and later, you can configure minimum and maximum rates for each circuit of a tunnel using the XGE ports on the FX8-24 blade. This provides a maximum guaranteed rate of 10 Gbps combined for all tunnels over a single 10 GbE port and a maximum rate of 10 Gbps for any single circuit. This feature is backwards-compatible with 1GbE ports on either the 7800 Extension Switch or FX8-24 Extension Blade. For connections between 10GbE ports, ARL is supported only if Fabric OS v7.0.0 and later is running on both switches.

FSPF link cost calculation when ARL is used

Fabric Shortest Path First (FSPF) is a link state path selection protocol that directs traffic along the shortest path between the source and destination based upon the link cost. When ARL is used, the link cost is equal to the sum of maximum traffic rates of all established, currently active low metric circuits in the tunnel. The following formulas are used:

- If the bandwidth is greater than or equal to 2 Gbps, the link cost is 500.
- If the bandwidth is less than 2 Gbps, but greater than or equal to 1 Gbps, the link cost is 1,000,000 divided by the bandwidth in Mbps.
- If the bandwidth is less than 1 Gbps, the link cost is 2000 minus the bandwidth in Mbps.

QoS SID/DID priorities over an FCIP trunk

QoS SID/DID traffic prioritization is a capability of the Fabric OS Adaptive Networking licensed feature. This feature allows you to prioritize FC traffic flows between initiators and targets.

Each circuit has four internal priorities that manage traffic over an FCIP tunnel, as illustrated in [Figure 7](#). The priorities are as follows:

- F class - F class is the highest priority, and is assigned bandwidth as needed at the expense of lower priorities, if necessary.
- QoS high - The default value is 50 percent of the available bandwidth.

2 QoS SID/DID priorities over an FCIP trunk

- QoS medium - The default value is 30 percent of the available bandwidth.
- QoS low - The default value is 20 percent of the available bandwidth.

For the 7800 switch and FX8-24 blade, you can modify the default values. Note that this only changes the QoS priority distribution in the tunnel and does not reconfigure the fabric. For the FR4-18i blade, there is no QoS distribution on the tunnel. Also, you cannot change the default values.

Change the priority percentages on the 8 Gbps platforms using the optional *Percentage* tunnel argument for the **portcfg fciptunnel create** and **portcfg fciptunnel modify** commands. When configuring QoS percentages for each level, remember the following:

- The three values must equal 100 percent.
- A minimum of 10 percent is required for each level.
- QoS priority settings must be the same on each end of the tunnel.

NOTE

Priorities are enforced only when there is congestion on the network. If there is no congestion, all traffic is handled at the same priority.

Following are some examples of setting QoS priority levels on VE_Port 12:

- The following command sets the QoS high priority to 60 percent.

```
portcfg fciptunnel 1/12 create --qos-high 60
```

- The following command sets the QoS medium priority to 30 percent.

```
portcfg fciptunnel 1/12 create --qos-medium 30
```

- The following command sets the QoS low priority to 10 percent.

```
portcfg fciptunnel 1/12 create --qos-low 10
```

For more information on using the **portcfg fciptunnel** command and optional tunnel arguments, refer to the *Fabric OS Command Reference Manual*.

[Figure 7](#) on page 23 illustrates the internal architecture of TCP connections that handle QoS SID/DID-based Fibre Channel traffic prioritization. Note that this illustrates a tunnel containing a single circuit only.

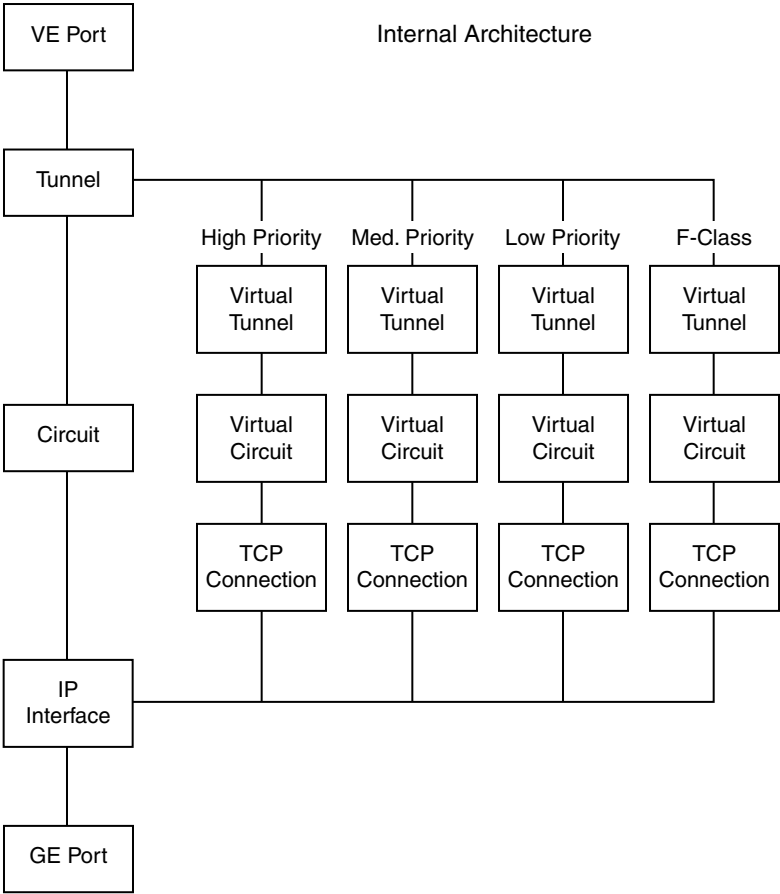

FIGURE 7 TCP connections for handling QoS SID/DID-based FC traffic prioritization

QoS, DSCP, and VLANs

Quality of Service (QoS) refers to policies for handling differences in data traffic. These policies are based on data characteristics and delivery requirements. For example, ordinary data traffic is tolerant of delays and dropped packets, but voice and video data are not. QoS policies provide a framework for accommodating these differences in data as it passes through a network.

QoS for Fibre Channel traffic is provided through internal QoS priorities. Those priorities can be mapped to TCP/IP network priorities. There are two options for TCP/IP network-based QoS:

- Layer 3 Differentiated Services Code Point (DSCP)
- VLAN tagging and Layer 2 Class of Service (L2CoS)

DSCP Quality of Service

Layer 3 Class of Service Differentiated Services Code Point (DSCP) refers to a specific implementation for establishing QoS policies as defined by RFC 2475. DSCP uses six bits of the Type of Service (TOS) field in the IP header to establish up to 64 different values to associate with data traffic priority.

DSCP settings are useful only if IP routers are configured to enforce QoS policies uniformly within the network. IP routers use the DSCP value as an index into a Per Hop Behavior (PHB) table. Control connections and data connections can be configured with different DSCP values. Before configuring DSCP settings, determine if the IP network you are using implements PHB, and consult with the WAN administrator to determine the appropriate DSCP values.

VLANs and Layer 2 Quality of Service

Devices in physical LANs are constrained by LAN boundaries. They are usually in close proximity to each other, and share the same broadcast and multicast domains. Physical LANs often contain devices and applications that have no logical relationship. Also, when logically related devices and applications reside in separate LAN domains, they must be routed from one domain to the other.

A VLAN is a virtual local area network. A VLAN can reside within a single physical network, or it can span several physical networks. Related devices and applications that are separated by physical LAN boundaries can reside in the same VLAN. Also, a large physical network can be broken into smaller VLANs. VLAN traffic is routed using 802.1Q-compliant tags within an Ethernet frame. The tag includes a unique VLAN ID, and Class of Service (CoS) priority bits. The CoS priority scheme (also called Layer 2 Class of Service or L2CoS) uses three Class of Service (CoS or 802.1P) priority bits, allowing eight priorities. Consult with your WAN administrator to determine usage.

When both DSCP and L2CoS are used

If an FCIP tunnel or circuit is VLAN tagged, both DSCP and L2CoS are relevant, unless the VLAN is end-to-end, with no intermediate hops in the IP network. [Table 4](#) shows the default mapping of DSCP priorities to L2CoS priorities. This may be helpful when consulting with the network administrator. These values are modified on a per-FCIP circuit basis for the 7800 switch and FX8-24 blade.

TABLE 4 Default mapping of DSCP priorities to L2CoS priorities

DSCP priority/bits	L2CoS priority/bits	Assigned to:
46 / 101110	7 / 111	Class F
7 / 000111	1 / 001	Medium QoS
11 / 001011	3 / 011	Medium QoS
15 / 001111	3 / 011	Medium QoS
19 / 010011	3 / 011	Medium QoS
23 / 010111	3 / 011	Medium QoS
27 / 011011	0 / 000	Class 3 Multicast
31 / 011111	0 / 000	Broadcast/Multicast
35 / 100011	0 / 000	Low QoS
39 / 100111	0 / 000	Low QoS
43 / 101011	4 / 100	High QoS
47 / 101111	4 / 100	High QoS
51 / 110011	4 / 100	High QoS
55 / 110111	4 / 100	High QoS
59 / 111011	4 / 100	High QoS
63 / 111111	0 / 000	Reserved

DSCP and VLAN support on FCIP circuits

When a VLAN tag is created on an FCIP circuit, all traffic over that circuit will use the specified VLAN. Options listed in [Table 5](#) are available on both the `portcfg fciptunnel` command to enable VLAN support on circuit 0, and on the `portcfg fcipcircuit` command for additional circuits.

TABLE 5 VLAN and DSCP options

Options	Description
VLAN	The <vlan_id> parameter sets the VLAN tag value in the header assigning the traffic to that specific VLAN. The VLAN tag is an integer value between 1 and 4094. Consult with your WAN administrator to discuss VLAN implementation.
-v	
--vlan-tagging <vlan_id>	

TABLE 5 VLAN and DSCP options (Continued)

Options	Description
L2CoS -- L2cos-f-class <n> -- L2cos-high <n> -- L2cos-medium<n> -- L2cos-low <n>	The IEEE 802.1P specification establishes eight levels of L2CoS priority. A value of 7 is the highest priority, and a value of 0 is the lowest priority. Consult with your WAN administrator to discuss L2CoS implementation.
DSCP --dscp-f-class <n> --dscp-high <n> --dscp-medium <n> --dscp-low <n>	The DSCP options allow you to specify a DSCP marking tag on a per-QoS basis for each FCIP circuit. On the 7800 switch and FX8-24 blade, only traffic going over the FCIP tunnel is marked. A decimal value from 0 through 63 may be used to specify the DSCP marking tag. Consult with your WAN administrator to discuss DSCP implementation before assigning a DSCP marking tag.

Examples

The following example shows the VLAN tag option on the **fciptunnel create** command. The VLAN tag applies only to circuit 0.

```
switch:admin> portcfg fciptunnel 16 create 192.168.2.20 192.168.2.10 100000 -v
100
Operation Succeeded
```

The following example creates an additional FCIP circuit with a different VLAN tag.

```
switch:admin> portcfg fcipcircuit 16 create 1 192.168.2.21 192.168.2.11 100000
-v 200
Operation Succeeded
```

The following example shows the **fcipcircuit modify** command that changes the VLAN tag and L2CoS levels for circuit 0. Parameters are the same for both the **create** and **modify** options.

```
switch:admin> portcfg fcipcircuit 16 modify 0 -v 300 --l2cos-f-class 7
--l2cos-high 5 --l2cos-medium 3 --l2cos-low 1
```

The following example shows the **fcipcircuit modify** command that changes the DSCP values for circuit 0. Parameters are the same for both the **create** and **modify** options.

```
switch:admin> portcfg fcipcircuit 16 modify 0 --dscp-f 32 --dscp-h 16 --dscp-m
8 --dscp-l 4
Operation Succeeded
```

The following example shows the use of the portshow command to display the tunnel and circuit values. Use the **-c** option as shown to include circuit values.

```
switch:admin> portshow fciptunnel 16 -c
```

Refer to the *Fabric OS Command Reference Manual* for detailed command syntax and output examples for the **fcipcircuit modify** command.

Managing the VLAN tag table

The VLAN tag table is used by ingress processing to filter inbound VLAN tagged frames per IP interface. The table is used to determine how to tag a frame that is not already tagged. If a VLAN tagged frame is received from the network and there is no entry in the VLAN tag table for the VLAN ID, the frame is discarded. The per IP interface VLAN configuration is for non-data path traffic only, such as ICMP, ping commands, etc. If Class-F traffic or data path traffic needs to be tagged, it must be done through the **-v, -vlan-tagging** option on the **fcipcircuit create** or **modify** command.

To tag frames destined for a specific host address, you must create an entry with an exact matching destination address in the table. Only frames destined for that address are tagged with the associated VLAN ID. To tag frames destined for a specific network, you must create a destination address entry for the network. For example; if a destination address of 192.168.100.0 is specified, then all frames destined for the 192.168.100.0 network are tagged with the associated VLAN ID, assuming a network mask of 255.255.255.0. If frames are already VLAN tagged, those tags take precedence over entries in this table.

NOTE

If you do not specify a destination IP address, the destination address defaults to 0.0.0.0, and all frames are tagged with the associated VLAN tag.

1. Connect to the switch and log in using an account assigned to the admin role.
2. Enter the **portCfg vlantag** command to add or delete entries in the VLAN tag table. The general syntax for the **portCfg vlantag** command is as follows:

```
portCfg vlantag add | delete ipif_addr vlan_id L2CoS [dst_IP_addr]
```

For full details on syntax and using this command, refer to the *Fabric OS Command Reference Manual*.

The following example adds an entry that tags all frames from IP address 192.168.10.1 destined for IP address 192.168.20.1 with a VLAN ID of 100, and a L2CoS value of 3.

```
switch:admin> portcfg vlantag 8/ge0 add 192.168.10.1 100 3 192.168.20.1
```

NOTE

To add entries with crossport addresses to the VLAN tag table, refer to [“Configuring VLAN tags with crossports”](#) on page 14.

For more details on using the **portCfg vlantag** command, refer to the *Fabric OS Command Reference Manual*.

Compression options

The following compression options are available on both the 7800 switch and the FX8-24 blade. Compression is defined on the FCIP tunnel.

- Standard - This is a hardware compression mode.
- Moderate - This is a combination of hardware and software compression that provides more compression than hardware compression alone. This option supports up to 8 Gbps of FC traffic.
- Aggressive - This is software-only compression that provides a more aggressive algorithm than used for the standard and moderate options. This option supports up to 2.5 Gbps of FC traffic.
- Auto - This allows the system to set the best compression mode based on the tunnel's configured bandwidth and the bandwidth of all tunnels in the system.

NOTE

Fibre Channel throughput for aggressive and moderate mode is dependent on the compression ratio for the data pattern.

Follow the guidelines for assigning explicit compression levels for tunnels in [Table 6](#).

TABLE 6 Assigning compression levels

Total effective tunnels bandwidth	Compression level
Equal to or Less than 512 Mbps	Aggressive
More than 512 and less than or equal to 2 Gbps	Moderate
More than 2 Gbps	Standard

IPsec implementation over FCIP tunnels

Internet Protocol security (IPsec) uses cryptographic security to ensure private, secure communications over Internet Protocol networks. IPsec supports network-level data integrity, data confidentiality, data origin authentication, and replay protection. It helps secure your SAN against network-based attacks from untrusted computers.

The following describes the sequence of events that invokes the IPsec protocol.

1. IPsec and Internet Key Exchange (IKE) policies are created and assigned on peer switches or blades on both ends of the FCIP tunnel.
2. Traffic from an IPsec peer with the lower local IP address initiates the IKE negotiation process.
3. IKE negotiates security association (SA) parameters, setting up matching SAs in the peers. Some of the negotiated SA parameters include encryption and authentication algorithms, Diffie-Hellman key exchange, and SA lifetimes.
4. Data is transferred between IPsec peers based on the IPsec parameters and keys stored in the SA database.
5. SA lifetimes terminate through deletion or by timing out. An SA lifetime equates to approximately two billion frames of traffic passed through the SA.

Limitations using IPsec over FCIP tunnels

The following limitations apply to using IPsec:

- Network Address Translation (NAT) is not supported.
- Authentication Header (AH) is not supported.
- IPsec-specific statistics are not supported.
- There is no RAS message support for IPsec.
- IPsec can only be configured on IPv4-based tunnels.
- IPsec is only supported on VE group 12-21 and not on group 22-31 on an FX8-24 blade.
- To enable IPsec with Fabric OS v7.0.0 and later, both ends of the tunnel must use v7.0.0 and later.

NOTE

IPsec is not allowed with the `-connection-type` FCIP tunnel option set to anything other than default.

IPsec for the 7800 switch and FX8-24 blade

Advanced Encryption Standard, Galois/Counter Mode, Encapsulating Security Payload (AES-GCM-ESP) is used as a single, predefined mode of operation for protecting all TCP traffic over an FCIP tunnel. AES-GCM-ESP is described in RFC 4106. The following list contains key features of AES-GCM-ESP:

- Encryption is provided by AES with 256-bit keys.
- The IKEv2 key exchange protocol is used by peer switches and blades for mutual authentication.
- IKEv2 uses UDP port 500 to communicate between the peer switches or blades.
- All IKE traffic is protected using AES-GCM-ESP encryption.
- Authentication requires the generation and configuration of 32-byte pre-shared secrets for each tunnel.
- An SHA-512 hash message authentication code (HMAC) is used to check data integrity and detect third-party tampering.
- Pseudo-random function (PRF) is used to strengthen security. The PRF algorithm generates output that appears to be random data, using the SHA-512 HMAC as the seed value.
- A 2048-bit Diffie-Hellman (DH) group is used for both IKEv2 and IPsec key generation.
- The SA lifetime limits the length of time a key is used. When the SA lifetime expires, a new key is generated, limiting the amount of time an attacker has to decipher a key. Depending on the length of time expired or the length of the data being transferred, parts of a message may be protected by different keys generated as the SA lifetime expires. For the 7800 switch and FX8-24 blade, the SA lifetime is approximately eight hours or two billion frames of data.
- Encapsulating Security Payload (ESP) is used as the transport mode. ESP uses a hash algorithm to calculate and verify an authentication value, and also encrypts the IP datagram.
- A circuit in a non-secure tunnel can use the same GbE interface as a circuit in a secure tunnel. Each circuit can have a route configured on that GbE interface.

Enabling IPsec and IKE policies

IPsec is enabled as an option of the `portcfg fciptunnel create` and `modify` commands. The `-i` option activates IPsec. The `-K` option specifies the IKE key. The `-l` (legacy) option specifies to use the IPsec connection process compatible with Fabric OS releases prior to v7.0.0. Note that this option is a disruptive modify request that causes the tunnel to bounce.

The IKE key must be a shared 32-character string. Both ends of the secure tunnel must be configured with the same key string. If both ends are not configured with the same key, the tunnel will not come up. The following examples show IPsec and IKE keys enabled for traffic from VE_Ports 16 and 17 across multiple FCIP circuits.

```
portcfg fciptunnel 16 create 192.168.0.90 192.168.0.80 50000 -x 0 -d c0 -i
-K12345678901234567890123456789012 -1
portcfg fcipcircuit 16 create 1 192.168.1.90 192.168.1.80 50000 -x 0
portcfg fcipcircuit 16 create 2 192.168.2.90 192.168.2.80 50000 -x 0
portcfg fcipcircuit 16 create 3 192.168.3.90 192.168.3.80 50000 -x 0
portcfg fcipcircuit 16 create 4 192.168.4.90 192.168.4.80 50000 -x 0
portcfg fcipcircuit 16 create 5 192.168.5.90 192.168.5.80 50000 -x 0

portcfg fciptunnel 17 create 192.168.0.91 192.168.0.81 50000 -x 0 -d c0 -i
-K12345678901234567890123456789012 -1
portcfg fcipcircuit 17 create 1 192.168.1.91 192.168.1.81 50000 -x 0
portcfg fcipcircuit 17 create 2 192.168.2.91 192.168.2.81 50000 -x 0
portcfg fcipcircuit 17 create 3 192.168.3.91 192.168.3.81 50000 -x 0
portcfg fcipcircuit 17 create 4 192.168.4.91 192.168.4.81 50000 -x 0
portcfg fcipcircuit 17 create 5 192.168.5.91 192.168.5.81 50000 -x 0
```

Open Systems Tape Pipelining

Open Systems Tape Pipelining (OSTP) can be used to enhance open systems SCSI tape write I/O performance. When the FCIP link is the slowest part of the network, OSTP can provide accelerated speeds for tape read and write I/O over FCIP tunnels. To use OSTP, you must enable both FCIP Fastwrite and Tape Pipelining.

OSTP accelerates SCSI read and write I/Os to sequential devices (such as tape drives) over FCIP, which reduces the number of round-trip times needed to complete the I/O over the IP network and speeds up the process. Each GbE port supports up to 2048 simultaneous accelerated exchanges.

Both sides of an FCIP tunnel must have matching configurations for these features to work. FCIP Fastwrite and OSTP are enabled by turning them on during the tunnel configuration process. They are enabled on a per-FCIP tunnel basis.

FCIP Fastwrite and OSTP configurations

The FCP features used in FCIP Fastwrite and OSTP require a deterministic FC Frame path between initiators and targets when multiple tunnels exist. If there are non-controlled parallel (equal-cost) tunnels between the same SID/DID pairs, protocol optimization will fail when a command is routed over one tunnel and the response is returned over a different tunnel. To help understand the supported configurations, consider the configurations shown in [Figure 8](#) and [Figure 9](#) on page 31. In both cases, there are no multiple equal-cost paths. In [Figure 8](#), there is a single tunnel with Fastwrite and OSTP enabled. In [Figure 9](#), there are multiple tunnels, but none of them create a multiple equal-cost path.

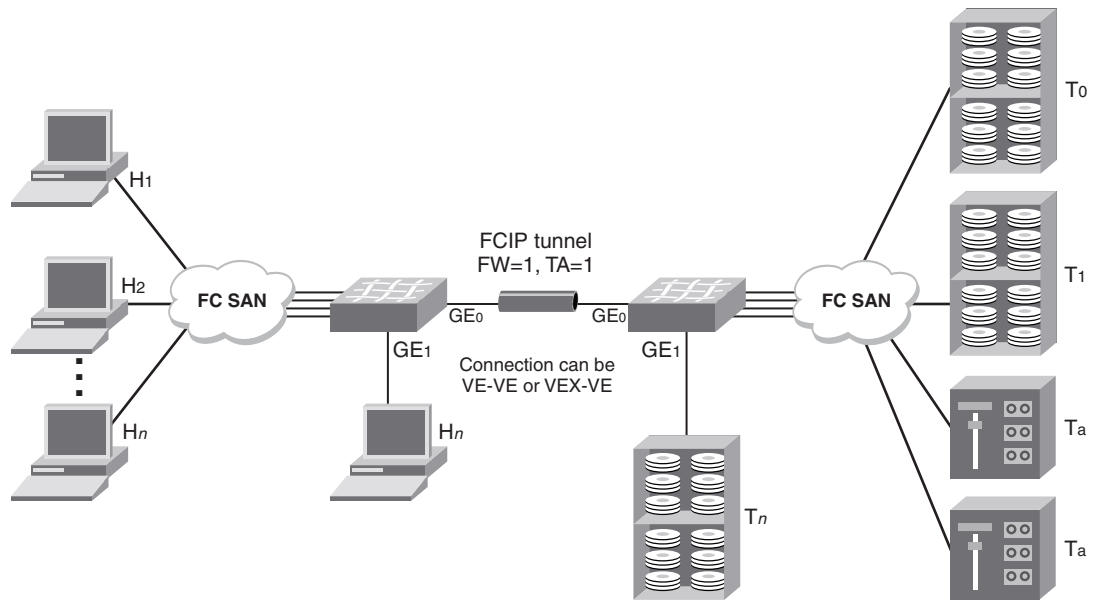

FIGURE 8 Single tunnel, Fastwrite and OSTP enabled

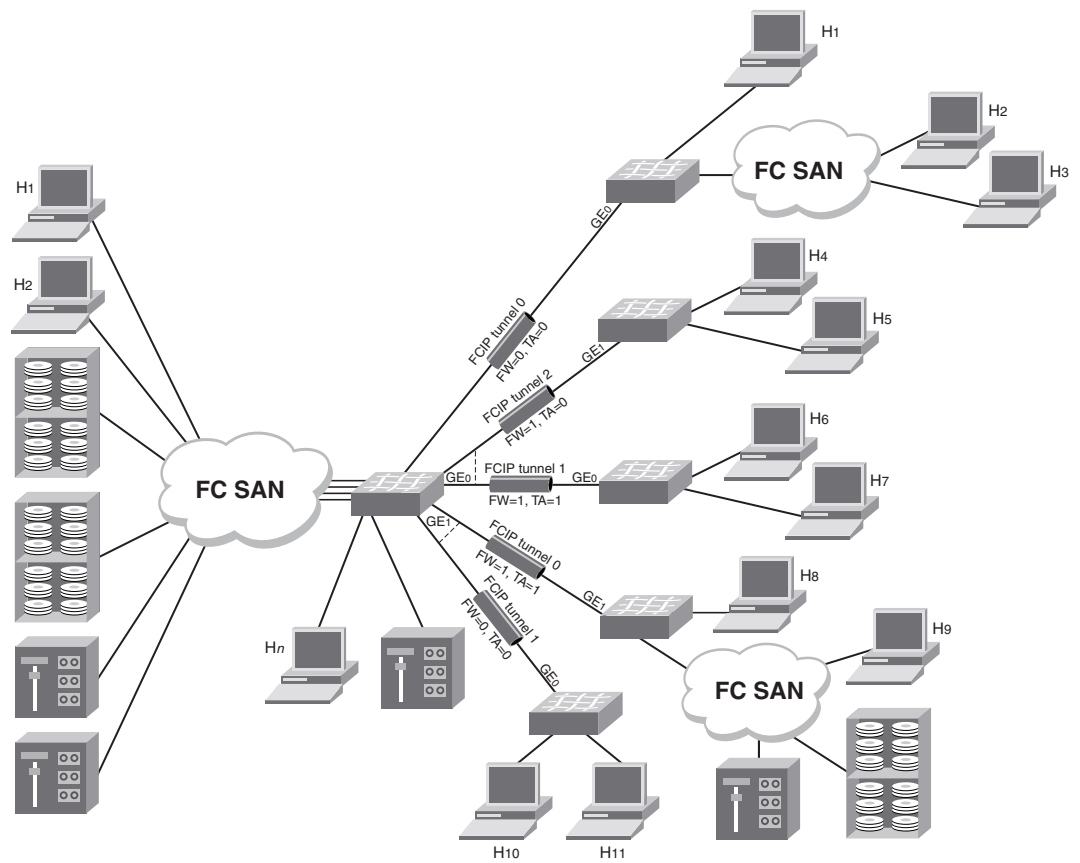

FIGURE 9 Multiple tunnels to multiple ports, Fastwrite and OSTP enabled on a per-tunnel/per-port basis

In some cases, traffic isolation zoning TI or LS/LF configurations may be used to control the routing of SID/DID pairs to individual tunnels and provide deterministic flows between the switches, allowing the use of multiple equal cost tunnels. Refer to the *Fabric OS Administrator's Guide* for more information about traffic isolation zoning.

Support for IPv6 addressing

The IPv6 implementation is a dual IP layer operation implementation as described in RFC 4213. IPv6 addresses can exist with IPv4 addresses on the same interface, but the FCIP circuits must be configured as IPv6-to-IPv6 and IPv4-to-IPv4 connections. IPv6-to-IPv4 connections are not supported. Likewise, encapsulation of IPv4 in IPv6 and IPv6 in IPv4 is not supported.

This implementation of IPv6 uses unicast addresses for the interfaces with FCIP circuits. Unicast addresses must follow the RFC 4291 IPv6 standard. This IPv6 implementation uses the IANA-assigned IPv6 Global Unicast address space (2000::/3). The starting three bits must be 001 (binary) unless IPv6 with embedded IPv4 addresses is used. The link-local unicast address is automatically configured on the interface, but using the link-local address space for FCIP circuit endpoints is not allowed. Site-local unicast addresses are not allowed as FCIP circuit endpoints.

Note the following IPv6 addressing points:

- Anycast addresses are not used. Each IPv6 interface has a unique unicast address and addresses configured are assumed to be unicast.
- Multicast addresses cannot be configured for an IPv6 interface with FCIP circuits. The IPv6 interface does not belong to any Multicast groups other than the All-Nodes Multicast and the Solicited-Node Multicast groups (these do not require user configuration).
- The IPv6 implementation follows the RFC 2460 standard for the 40-byte IPv6 header format.
- The IPv6 8-bit Traffic class field is defined by the configured Differentiated Services field for IPv6 (RFC 2474). The configuration of this is done on the FCIP circuit using the Differentiated Services Code Point (DSCP) parameters to fill the 6-bit DSCP field.
- Flow labels are not supported on this IPv6 implementation. The 20-bit Flow Label field defaults to all zeros.
- The IPv6 optional Extension Headers are not supported. The optional Extension Headers inserted into any ingress packets that contain these headers will be discarded. The next header field must be the Layer 4 protocol for this implementation.
- Parts of the Neighbor Discovery protocol (RFC 4861) are used in this implementation.
 - Hop limits (such as Time to Live (TTL)) are learned from the Neighbor Advertisement packet.
 - The link-local addresses of neighbors are learned from Neighbor Advertisement.
 - The netmask is deprecated in IPv6. Instead, the prefix length notation is used to denote subnets in IPv6 (the Classless Inter-Domain Routing (CIDR) addressing syntax). Prefix length of neighbor nodes is learned from the received Neighbor Advertisement packet.
 - The IPv6 link-local address for each GE interface is configured at startup and advertised to neighbors. The user does not configure the interface link-local address.
- The 8-bit hop limit field is filled by the learned value during Neighbor Discovery.
- IPv6 addresses and routes must be statically configured by the user. Router Advertisements and IPv6 Stateless Address Autoconfiguration (RFC 2462) are not supported.

- The Neighbor Discovery ICMPv6 Solicitations and Advertisements are transmitted to the Layer 2 Ethernet multicast MAC address derived from the IPv6 source address (RFC 2464).
- ICMPv6 message types in RFC 4443 and ICMPv6 message types used for Neighbor Discovery are supported.
- Path MTU Discovery (RFC 1981) is not supported on this implementation, requiring static configuration of MTU size. The maximum MTU supported is 1500 bytes (including the 40-byte fixed IPv6 header), the same as for IPv4. The minimum MTU allowed is 1280 bytes (including the 40-byte fixed IPv6 header). Any network used for IPv6 FCIP circuits must support an MTU of 1280 bytes or larger. IPv6 fragmentation is not supported. The Layer 4 protocol ensures that the PDU is less than the MTU (including headers).
- The IPv6 addressing currently cannot be used when implementing IPsec.

IPv6 with embedded IPv4 addresses

Only IPv4-compatible IPv6 addresses are supported. Only the low-order 32 bits of the address can be used as an IPv4 address (high-order 96 bits must be all zeros). This allows IPv6 addresses to be used on an IPv4 routing infrastructure that supports IPv6 tunneling over the network. Both endpoints of the circuit must be configured with IPv4-compatible IPv6 addresses. IPv4-to-IPv6 connections are not supported. IPv4-mapped IPv6 addresses are not supported, because they are intended for nodes that support IPv4 only when mapped to an IPv6 node.

Configuration preparation

Before you begin to configure FCIP, do the following:

- Determine the amount of bandwidth that will be required for the RDR, FICON, or tape application to be deployed.
- The WAN link has been provisioned and tested for integrity.
- Cabling within the data center has been completed.
- Equipment has been physically installed and powered on.
- Make sure you have admin access to all switches and blades you need to configure.
- For the 7800 switch, determine if copper or optical ports will be used for GbE ports 0 and 1.
- For the FX8-24 blade, determine which of the three possible GbE port operating modes will be used.
- Determine which 10GbE crossports on FX8-24 blades should get active versus passive or active versus active configurations.
- Obtain IP addresses for each GbE port you intend to use, plus the netmask and MTU size.

NOTE

The 7800 switch and FX8-24 blade support a maximum MTU size of 1500.

- Determine the gateway IP address and netmask as needed for each route across the WAN.
- Determine if there is any reason to turn off selective acknowledgement (SACK). Because SACK improves performance for most installations, it is turned on by default.
- Determine the VE_Port numbers you want to use. The VE_Port numbers serve as tunnel IDs.

2 Configuration steps

- Determine source and destination IP addresses for circuit 0, and the minimum and maximum committed rates for circuit 0. These values are set by the **portCfg fciptunnel create** command.
- Determine how many additional FCIP circuits you want to create. You will need the source and destination IP addresses for the circuit, and the minimum and maximum committed rates for the circuit. You will need to know if you intend to assign metrics to circuits to implement standby circuits. For all circuits except circuit 0, these values are set by the **portCfg fcipcircuit create** command.

Configuration steps

The following is a list of the major steps in configuring FCIP on the 7800 switch or FX8-24 blade:

- Persistently disable VE_Ports.
- If required, configure VEX_Ports.
- For the 7800 switch, set the media type for GbE ports 0 and 1.
- For the FX8-24 blade, set the GbE port operating mode.
- Assign IP addresses to the GbE ports.
- Create one or more IP routes using the **portCfg iproute** command.
- Test the IP connection using the **portCmd -ping** command.
- Create FCIP tunnels and FCIP circuits, and enable or disable features.
- Persistently enable the VE_Ports.

Setting VE_Ports to persistently disabled state

It is strongly recommended to persistently disable VE_Ports while tunnel configuration is in progress. This will prevent unwanted fabric merges from occurring until the FCIP tunnel is fully configured. You must change their state from persistently enabled to persistently disabled. Once the FCIP tunnels have been fully configured on both ends of the tunnel, you can persistently enable the ports.

1. Enter the **portCfgShow** command to view ports that are persistently disabled.
2. Enter the **portCfgPersistentDisable** command to disable any VE_Ports that you will use in the FCIP tunnel configuration.

Configuring VEX_Ports

If you are going to use a VEX_Port in your tunnel configuration, use the **portCfgVEXPort** command to configure the port as a VEX_Port. VEX_Ports can be used to avoid merging fabrics over distance in FCIP implementations.

If the fabric is already connected, disable the GbE ports and do not enable them until after you have configured the VEX_Port. This prevents unintentional merging of the two fabrics.

VEX_Ports are described in detail in the “Using the FC-FC Routing Service” chapter of the *Fabric OS Administrator’s Guide*. Refer to that publication if you intend to implement a VEX_Port.

The following example configures a VEX_Port, enables admin, and specifies fabric ID 2 and preferred domain ID 220:

```
switch:admin> portcfgvexport 18 -a 1 -f 2 -d 220
```

Enabling XISL for VE_Ports

An Extended Interswitch Link (XISL) is a special ISL that can carry combined traffic for multiple logical fabrics while maintaining traffic separation for each fabric. An XISL connection is created between user-defined logical switches, called base switches, instead of using separate ISLs between logical switches. The base fabric provides the physical connectivity across which logical connectivity will be established. Because of the expense of long-distance links, this feature has particular benefit for the FCIP extension platforms. This feature is supported only on tunnels between FX8-24 blades running Fabric OS v7.0 and later. The blades can be operating in both 1 Gbps and 10 Gbps modes.

To use XISL, add the *Enable XISL Use* parameter to the **configure** command for the logical switch where you intend to use XISL with VE_Ports. Refer to the *Fabric OS Command Reference Manual* for details.

Configuring the media type for GbE ports 0 and 1 (7800 switch only)

Two media types are supported for GbE ports 0 and 1 on the 7800 switch; copper and optical. The media type must be set for GbE ports 0 and 1 using the **portcfggemediatype** command. The following example configures port 1 (ge1) in optical mode.

```
switch:admin> portcfggemediatype ge1 optical
```

The command options are as follows:

ge0|ge1 **ge0** for port 0 or **ge1** for port 1.

copper|optical The media type.

When you enter this command without specifying the media type, the current media type for the specified GbE port is displayed, as in the following example.

```
switch:admin> portcfggemediatype ge1
Port ge1 is configured in optical mode
```

Setting the GbE port operating mode (FX8-24 blade only)

The GbE ports on an FX8-24 blade can operate in one of three ways:

- 1 Gbps mode. GbE ports 0 through 9 may be enabled as GbE ports, with the XGE ports disabled. The 10GbE (FTR_10G) license is not required.
- 10 Gbps mode. 10GbE ports xge0 and xge1 may be enabled, with GbE ports 0 through 9 disabled. The 10GbE (FTR_10G) license is required and must be assigned to the slot in which the FX8-24 blade resides.
- Dual mode. GbE ports 0 through 9 and 10GbE port xge0 may be enabled, with xge1 disabled. The 10GbE (FTR_10G) license is required and must be assigned to the slot in which the FX8-24 blade resides.

NOTE

Switching between 10Gbps mode and 1Gbps mode disrupts FCIP traffic.

NOTE

Before changing operating modes for a port, you must delete the port's FCIP configuration.

You must configure the desired GbE port mode of operation for the FX8-24 blade using the **bladeCfgGeMode** `--set <mode> -slot <slot number>` command. The command options are as follows.

- `--set <mode>`
 - 1g** enables the GbE ports 0 through 9 (xge0 and xge1 are disabled).
 - 10g** enables ports xge0 and xge1 (ge0-ge9 ports are disabled).
 - dual** enables the GbE ports 0 through 9 and xge0 (xge1 is disabled).
- `-slot <slot number>` Specifies the slot number for the FX8-24 blade.

The following example enables GbE ports 0 through 9 on an FX8-24 blade in slot 8. Ports xge0 and xge1 are disabled.

```
switch:admin> bladecfggemode --set 1g -slot 8
```

You can use the **bladecfggemode** `--show` command to display the GbE port mode for the FX8-24 blade in slot 8, as shown in the following example.

```
switch:admin> bladecfggemode --show -slot 8
bladeCfgGeMode: Blade in slot 8 is configured in 1GigE Mode
1GigE mode: ge0-9 ports are enabled (xge0 and xge1 are disabled)
switch:admin>
```

Configuring a GbE or XGE port IP address

You must configure an IP address, netmask, and an MTU size for each GbE port that you intend to use. This is done using the **portCfg ipif create** command. The following examples create the addressing needed for the basic sample configuration in [Figure 10](#).

The following command creates an IP interface for port ge0 on the FX8-24 blade in slot 8 of the Brocade DCX-4S.

```
switch:admin> portcfg ipif 8/ge0 create 192.168.1.24 255.255.255.0 1500
```

The following command creates an IP interface for port ge0 on the Brocade 7800 switch.

```
switch:admin> portcfg ipif ge0 create 192.168.1.78 255.255.255.0 1500
```

NOTE

For full details on syntax and using this command, refer to the *Fabric OS Command Reference Manual*.

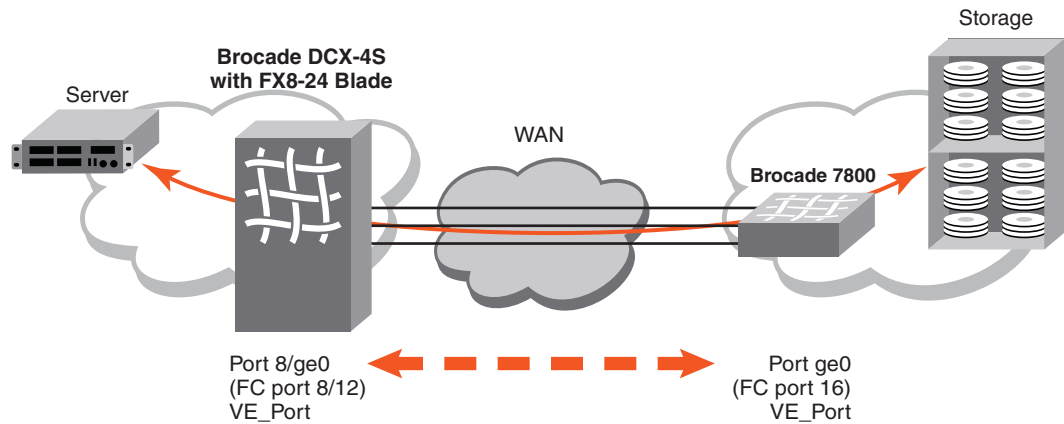

FIGURE 10 Basic sample configuration

There are no addressing restrictions for IPv4 and IPv6 connections with both switches or blades in the tunnel running Fabric OS v7.0 and later.

Configuring an IP route

Routing is based on the destination IP address presented by an FCIP circuit. If the destination address is not on the same subnet as the GbE port IP address, you need to configure an IP route to that destination with an IP gateway on the same subnet as the local GbE port IP address. To configure the route, use the **portCfg iproute create** command. Up to 32 IP routes may be defined for each GbE port. [Figure 11](#) adds an IP route for the basic sample configuration.

The following command creates an IP route to destination network 192.168.11.0 for port ge0 on the FX8-24 blade in slot 8 of the Brocade DCX-4S. The route is through local gateway 192.168.1.1.

```
switch:admin> portcfg iproute 8/ge0 create 192.168.11.0 255.255.255.0 192.168.1.1
```

The following command creates an IP route to destination network 192.168.1.0 for port ge0 on the Brocade 7800 switch. The route is through local gateway 192.168.11.1.

```
switch:admin> portcfg iproute ge0 create 192.168.1.0 255.255.255.0 192.168.11.1
```

2 Configuration steps

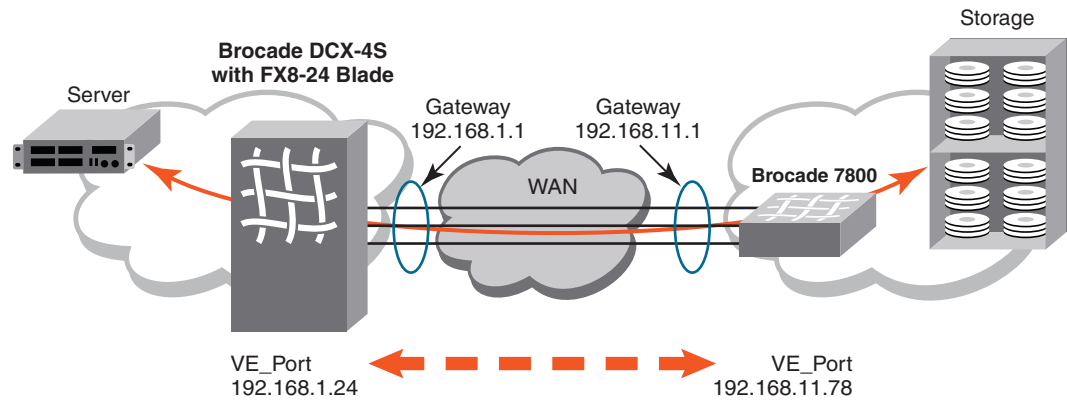

FIGURE 11 Configuring an IP route

For information on configuring IP routes using crossport addresses, refer to [“Configuring IP routes with crossports”](#) on page 14.

Validating IP connectivity

After you have established the IP interfaces and an IP route, you can issue a `portcmd --ping` command to verify connectivity.

The following example tests the connectivity between the FX8-24 blade and 7800 switch in the basic sample configuration from the 7800 switch. The `-s` option specifies the source address, and the `-d` option specifies the destination address.

```
switch:admin> portcmd --ping ge0 -s 192.168.11.78 -d 192.168.1.24
```

NOTE

To ping crossport addresses, refer to [“Using ping with crossports”](#) on page 14.

For full details on syntax and using this command, refer to the *Fabric OS Command Reference Manual*.

Creating an FCIP tunnel

FCIP tunnels are created using the `portCfg fciptunnel create` command.

The following command creates the FX8-24 end of the tunnel. VE_Port 12 is specified. Circuit parameters are included to create circuit 0. The 7800 switch destination address is specified first, followed by the FX8-24 source address. ARL minimum and maximum committed rates are specified for circuit 0.

```
switch:admin> portcfg fciptunnel 8/12 create 192.168.11.78 192.168.1.24  
-b 5500 -B 6200
```

The following command creates the 7800 end of the tunnel. VE_Port 16 is specified. Circuit parameters are included to create circuit 0 on the 7800. The circuit parameters must match up correctly with the circuit parameters on the FX8-24 end of the circuit. The FX8-24 destination address is specified first, followed by the 7800 switch source address. Matching ARL minimum and maximum committed rates must be specified on both ends of circuit 0.

```
switch:admin> portcfg fciptunnel 16 create 192.168.1.24 192.168.11.78
-b 5500 -B 6200
```

Figure 12 illustrates the results of the configuration.

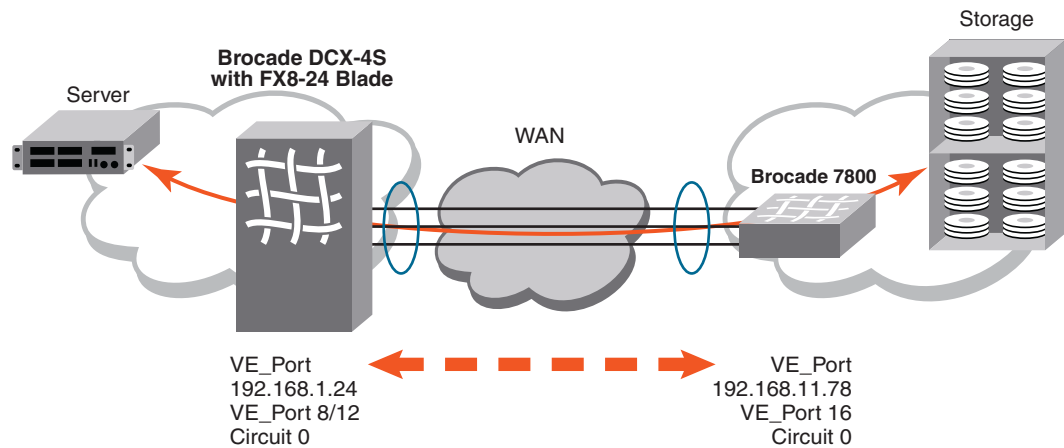

FIGURE 12 Adding an FCIP tunnel to the basic sample configuration

You can create a tunnel with no circuit parameters. This may be useful in staging a configuration without committing specific circuit parameters.

Most FCIP features are enabled using optional arguments available on the **portcfg fciptunnel create** command and the **portcfg fciptunnel modify** command. Some of these arguments apply only to FCIP tunnels, and are used only on the **portcfg fciptunnel create** command and the **portcfg fciptunnel modify** commands. FCIP tunnel options are summarized in [Table 7](#) on page 40.

NOTE

When circuit options are specified on the **portcfg fciptunnel create** command and the **portcfg fciptunnel modify** command, they apply only to circuit 0. When additional circuits are added, circuit options must be applied per circuit using the **portcfg fcipcircuit create** or the **portcfg fcipcircuit modify** command.

Other options apply to FCIP circuits. Circuit options are described in [Table 8](#) on page 42.

TABLE 7 Tunnel options

Option	Arguments	Disruptive	Description
Compression	Short option: -c Long option: --compression Operands: 0 1 2 3 4 	Yes	Enables compression on an FCIP tunnel. Compression is set by the portCfg fciptunnel create or modify command, and applies to traffic over all circuits in the tunnel. Compression cannot be set or modified by the portCfg fcipcircuit create or modify command. The argument values have the following meanings. 0 - Disables compression 1 - Enables Standard compression mode 2 - Enables Moderate compression mode 3 - Enables Aggressive compression mode 4 - Enables Auto compression mode For a description of the compression modes, refer to “Compression options” on page 28.
FCIP Fastwrite	Short option: -f Long option: --fast-write Operands (modify only): 0 1 <ul style="list-style-type: none"> • Create behavior: No operands required. FCIP Fastwrite enabled if specified on create. • Modify behavior: Requires operands. 	Yes	Disables or enables FCIP Fastwrite. A value of 1 enables FCIP Fastwrite. A value of 0 disables FCIP Fastwrite. FCIP Fastwrite is initially disabled, and must be enabled to take effect.
OSTP	Short option: -t Long option: --tape-pipelining Operands (modify only): 0 1 2 <ul style="list-style-type: none"> • Create behavior: Operands not required. OSIP enabled when specified on create. • Modify behavior: Requires operands. 	Yes	Disables or enables tape OSTP. A value of 1 enables OSTP. A value of 0 disables OSTP. OSTP is initially disabled. Both FCIP Fastwrite and OSTP must be enabled if you want to implement OSTP, as described in “Open Systems Tape Pipelining” on page 30. The argument values have the following meanings. 0 - OSTP Disabled 1 - OSTP Read/Write Enabled 2 - OSTP Write Enabled
QoS Priority Percentages	Short option: -q -high, -q -medium, -q -low Long option: --qos-high, --qos-medium, --qos-low Operands: <i>Percentage</i> . Whole values from 1-100.	Yes	Sets Quality of Service (QoS) priority percentages to different values from default values of 50% for QoS high, 30% for QoS medium, and 20% for QoS low. Priorities are enforced only when there is congestion on the network. If there is no congestion, all traffic is handled at the same priority. For more information on QoS and setting values, refer to “QoS SID/DID priorities over an FCIP trunk” on page 21.

TABLE 7 Tunnel options (Continued)

Option	Arguments	Disruptive	Description
Remote FC WWN	Short Option: -n Long Option: --remote-wwn <remote-WWN>	Yes	This is a fabric security feature that allows you to only allow the FCIP tunnel to come up when the correct remote WWN is entered. If the WWN of the remote side does not match the value entered here, the FCIP tunnel will not initiate.
Enable IPsec	Short Option: -i Long Option: --ipsec Operands (modify only): 0 1 <ul style="list-style-type: none"> • Create behavior: Operands are not required. IPsec enabled when specified on create. • Modify behavior: Requires operands. 	Yes	Disables (0) or enables (1) IPsec on this FCIP tunnel. Refer to “IPsec implementation over FCIP tunnels” on page 28 for information about IPsec policies.
Legacy IPsec connection	Short Option: -l Long Option: --legacy Operands (modify only): 0 1 <ul style="list-style-type: none"> • Create behavior: Operands are not required. Legacy IPsec enabled when specified on create. • Modify behavior: Requires operands. 	Yes	Disables (0) or enables (1) legacy IPsec mode. This mode uses the IPsec connection process compatible with Fabric OS versions prior to v7.0.0.
IKE V2 authentication Key for IPsec	Short Option: -K Long Option: --key Operands (modify and create): <key>	Yes	The pre-shared key used during IKE authentication.
FICON mode	Short Option: -F Long Option: --ficon Operands (modify only): 0 1 <ul style="list-style-type: none"> • Create behavior: Operands are not required. FICON mode enabled when specified on create. • Modify behavior: Requires operands. 	Yes	Disables (0) or enables (1) FICON mode.

TABLE 8 Circuit options

Option	Argument	Disruptive	Description
Committed rate	<p><committed rate></p> <p>Create behavior: Sets the minimum and maximum committed rate to the value specified for <committed rate>.</p> <p>Short option: -b or -B</p>	Yes	<p>This option may be used on a portcfg fciptunnel create command or on the portcfg fcipcircuit create command to set a committed rate for an FCIP circuit. When this option is used on the portcfg fciptunnel create command, the committed rate applies only to circuit 0. To modify the committed rate or if you intend to use ARL on the circuit, use the -b and -B options to set the minimum and maximum committed rates.</p>
Adaptive rate limiting (ARL)	<p>Short option: -b</p> <p>Long option: -min-comm-rate</p> <p>Operands: <kbps></p>	Yes	<p>The minimum committed rate is a guaranteed minimum traffic rate for an FCIP circuit. The valid ranges for -min-comm-rate are 10,000 Kbps through 1,000,000 Kbps for GbE ports and 10,100 Kbps to 100,000 Kbps for 10 GbE ports</p> <p>NOTE: When added together, the minimum committed rates for all circuits cannot exceed the speed of the GbE port.</p>
	<p>Short option: -B</p> <p>Long option: -max-comm-rate</p> <p>Operands: <kbps></p>	Yes	<p>The maximum committed rate is the rate that the tunnel will try to achieve, based on bandwidth availability and network performance. The valid ranges for -min-comm-rate are 10,000 Kbps through 1,000,000 Kbps for GbE ports and 10,100 Kbps to 100,000 Kbps for 10 GbE ports</p> <p>NOTE: When ARL is used, The link cost is equal to the sum of the maximum traffic rates of all established and currently active lowest metric circuits in the tunnel.</p>
Selective acknowledgement	<p>Short option: -s</p> <p>Long option: -sack</p> <p>Operands (modify only): 0 1</p> <ul style="list-style-type: none"> Create behavior: Operands are not required. Selective Acknowledgement will be disabled when specified on create. Modify behavior: Requires operands. 	Yes	<p>Disables or enables selective acknowledgement. Selective acknowledgement allows a receiver to acknowledge multiple lost packets with a single ACK response. This results in better performance and faster recovery time. Selective acknowledgement is initially turned on. For some applications and in some situations, you may need to turn selective acknowledgement off. This option is used to toggle the option off and on.</p>
Keep-alive timeout	<p>Short option: -k</p> <p>Long option: -keepalive-timeout</p> <p>Operands: <ms></p>	Yes	<p>The keep-alive timeout in seconds. The range of valid values is 8 through 7,200 seconds, and the default is 10. Refer to “Keep-alive timeout option” on page 44 for more information.</p>

TABLE 8 Circuit options (Continued)

Option	Argument	Disruptive	Description
Minimum retransmit time	Short option: -m Long option: -min-retrans-time Operands: <i><ms></i>	No	The minimum retransmit time, in milliseconds. The range of valid values is 20 through 5,000 ms and the default is 100 ms.
Failover/standby metric	Short option: -x Long option: -metric Operands: 0 1	Yes	You can configure standby circuits by assigning a metric. Refer to “FCIP circuit failover capabilities” on page 17 for a description of circuit failover and the use of standby circuits.
VLAN Tagging	Short option: -v Long option: -vlan-tagging Operands: <i><vlan-id></i>	Yes	Applies VLAN tagging to a circuit and sets a specific Layer 2 Class of Service (CoS). Specify a <i>vlan_id</i> . Valid values are from 1 through 4095 and the default is 1. Refer to “QoS, DSCP, and VLANs” on page 24 for information about VLAN tagging.
Class of Service (CoS)	Class of Service options (use with VLAN tagging options and operand): --l2cos-f-class <i><n></i> --l2cos-high <i><n></i> --l2cos-medium <i><n></i> --l2cos-low <i><n></i>	No	Sets the Layer 2 Class Of Service (L2CoS) options for VLAN tagging. Options are for F-Class traffic, and high, medium, and low priority traffic. Specify a value for <i><n></i> from 0 through 7 (default is 0).
DSCP Tagging	DSCP tag options (use with VLAN tagging options and operand): -dscp-f-class <i><n></i> -dscp-high <i><n></i> -dscp-medium <i><n></i> -dscp-low <i><n></i>	No	Applies a DSCP tag to a circuit. Specify a value for <i><n></i> from 0 through 63 (default is 0). Refer to “QoS, DSCP, and VLANs” on page 24 for information about DSCP tagging.
Specify connection type	Short option: -C Long option: -connection-type Operands: default listener initiator	Yes	Allows you to specify which side of the circuit is the listener or initiator. If this is not specified, the initiator or listener are automatically selected based on the lower and higher-order IP address. In NAT environments, this can cause problems as both sides of the circuit may have lower-order addresses. When setting initiator or listener options, a firmware download to a previous version will not be allowed until you set the default option.
Maximum retransmits	Short option: -r Long option: -max-retransmits Operands: <i><rtx></i>	No	Sets the maximum number of retransmits for the FCIP circuit before the connection will be brought down. If operating on a lossy network, increasing this value may allow the FCIP circuit to remain active when it may otherwise fail. Specify a value for <i><rtx></i> from 1 through 16 (default is 8).
Administrative status	Short option: -a Long option: -admin-status Operands (modify and create): 0 1	Yes	Disables or enables the FCIP circuit.

Keep-alive timeout option

Consider the following items when configuring the keep-alive timeout option:

- A FICON tunnel requires a keep-alive timeout of less than or equal to 1 second for each FCIP circuit added to a tunnel.
- If the tunnel is created first with the FICON flag, then the keep-alive timeout for all added circuits will be 1 second (recommended value for FICON configurations).
- If the tunnel is created with one or more circuits, and then the tunnel is modified to be a FICON tunnel, then the circuits that were previously created must be modified to have the correct keep-alive timeout value.
- Set the FCIP circuit keep-alive timeout to the same value on both ends of an FCIP tunnel. If local and remote circuit configurations do not match, the tunnel will use the lower of the configured values.
- For normal operations over FCIP tunnels, the keep-alive timeouts for all FCIP circuits in an FCIP tunnel must be less than the overall I/O timeout for all FC exchanges. If the FC I/O timeout value is less than the keep-alive timeout value, then I/Os will time out over all available FCIP circuits without being retried.

The keep-alive value should be based on application requirements. Check with your FC initiator providers to determine the appropriate keep-alive timeout value for your application. The sum of keep-alive timeouts for all circuits in a tunnel should be close to the overall FC initiator I/O timeout value. As an example, a mirroring application has a 6-second I/O timeout. There are three circuits in the FCIP tunnel. Set the keep-alive timeout to 2 seconds on each FCIP circuit. This will allow for maximum retries over all available FCIP circuits before an I/O is timed out by the initiator.

Refer to the **portcfg fcipcircuit** keep-alive timeout option in [Table 8](#) on page 42 for information on option format and value range.

Creating additional FCIP circuits

If the Advanced Extension (FTR_AE) license is enabled, additional FCIP circuits can be created and added to an FCIP tunnel using the **portCfg fcipcircuit create** command. The following examples add a circuit to the tunnel in the basic sample configuration (refer to [Figure 12](#) on page 39).

The following command creates circuit 1 on the FX8-24 end of the tunnel.

```
switch:admin> portcfg fcipcircuit 8/12 create 1 192.168.11.79 192.168.1.25 -b 15500 -B 62000
```

The following command creates circuit 1 on the 7800 switch end of the tunnel.

```
switch:admin> portcfg fcipcircuit 16 create 1 192.168.1.25 192.168.11.79 -b 15500 -B 62000
```

Note the following:

- The VE_Ports used to create the tunnel are the same as specified on the FCIP tunnel in the basic sample configuration. The VE_Ports uniquely identify the tunnel, and the circuit is associated with this specific tunnel.
- The unique destination and source IP addresses are mirrored on either end of the tunnel. The address 192.168.11.79 is the destination address for the FX8-24 blade, and the source address for the 7800 switch, while the address 192.168.1.25 is the destination address for the 7800 switch, and the source address for the FX8-24 blade.

- ARL minimum and maximum rates are set per circuit. They must be the same on either end of a circuit, but individual circuits may have different rates.
- You can configure standby circuits by assigning a metric. In the following example, circuit 2 is used only when circuit 1 fails. Refer to “[FCIP circuit failover capabilities](#)” on page 17 for a description of circuit failover and the use of standby circuits.

```
switch:admin> portcfg fcipcircuit 8/12 create 1 192.168.11.79 192.168.1.25 -b
15500 -B 62000
switch:admin> portcfg fcipcircuit 8/12 create 2 192.168.11.8 192.168.1.26 -b
15500 -B 62000 -x 1
```

- When multiple FCIP tunnels are present on a switch and additional circuits are added to an active tunnel, some frame loss can occur for a short period of time because the internal Fibre Channel frame routing tables in the switch are refreshing. Therefore, add additional circuits only during low I/O periods on the FCIP tunnel being modified. In addition, if deleting or adding a circuit increases or decreases the total tunnel bandwidth, then disable and re-enable the tunnel (VE_Port) after deleting or adding the circuit. This will allow the switch to adjust internal routes to fully utilize the new bandwidth.

Verifying the FCIP tunnel configuration on the Brocade 7800 FX8-24

After you have created local and remote FCIP configurations, verify that the FCIP tunnel and circuit parameters are correct using the **portshow fciptunnel** command. Refer to the *Fabric OS Command Reference Manual* for a description of the command syntax and output.

Enabling persistently disabled ports on the Brocade 7800 FX8-24

It is strongly recommended to disable ports while they are being configured to prevent unwanted fabric merges.

1. Connect to the switch and log in using an account assigned to the admin role.
2. Enter the **portCfgShow** command to view ports that are persistently disabled.
3. After identifying the ports, enter the **portCfgPersistentEnable** command to enable the ports.
4. Enter the **portCfgShow** command to verify the port is persistently enabled.

Creating a multicircuit tunnel (example)

This section provides procedures and applicable commands to create a tunnel containing six circuits between two switches or blades. [Figure 13](#) illustrates an example of these circuits between two FX8-24 blades inside a DCX chassis.

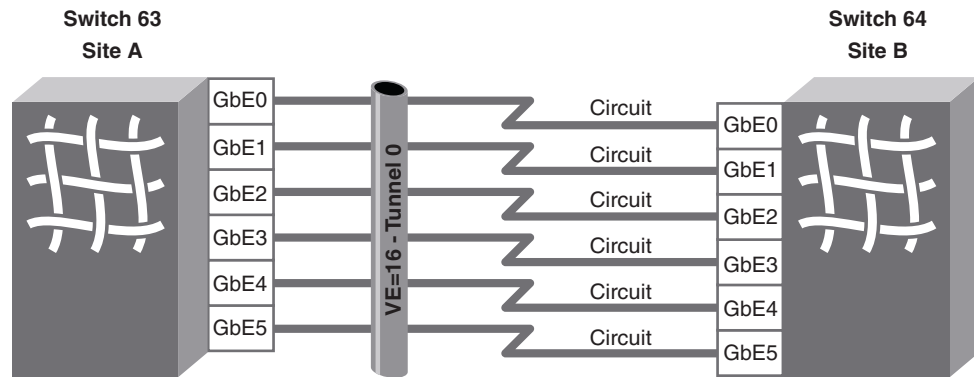

FIGURE 13 FCIP tunnel example with six circuits

Although six circuits per tunnel are configured in the example and six circuits is the maximum for the 7800 switch or FX8-24 blade, you can create less circuits if you desire. To create multiple tunnels, simply configure tunnels and circuits for these tunnels. For details, refer to the following sections of this guide:

- [“Configuring a GbE or XGE port IP address”](#) on page 36
- [“Configuring an IP route”](#) on page 37
- [“Creating an FCIP tunnel”](#) on page 38
- [“Creating additional FCIP circuits”](#) on page 44

To create a tunnel between two switches or blades, you must first understand the IP network infrastructure between the sites. Each circuit requires a pair of IP interface addresses (either IPv4 or IPv6). Therefore, to create an FCIP Tunnel with six circuits, you need 12 IP addresses: six for the site A switch and six for the site B switch. In the simplest configuration (non-routed), the IP addresses can all be on the same IP subnet. In routed configurations, you will also define IP routes (IP gateway addresses). In the following example, six different IP subnets are used, although this is not a requirement.

Use the following steps for the multicircuit tunnel example illustrated in [Figure 13](#) on page 46.

1. Assign IP addresses to each switch GbE port using the `portcfg ipif` command. The `portcfg ipif` command requires the IP address, subnet mask, and the MTU for that IP interface. The following examples show how to create the IP interfaces (IPIFs) for this configuration.

Site A

```
portcfg ipif ge0 create 192.168.0.63 255.255.255.0 1500
portcfg ipif ge1 create 192.168.1.63 255.255.255.0 1500
portcfg ipif ge2 create 192.168.2.63 255.255.255.0 1500
portcfg ipif ge3 create 192.168.3.63 255.255.255.0 1500
portcfg ipif ge4 create 192.168.4.63 255.255.255.0 1500
portcfg ipif ge5 create 192.168.5.63 255.255.255.0 1500
```

Site B

```
portcfg ipif ge0 create 192.168.0.64 255.255.255.0 1500
portcfg ipif ge1 create 192.168.1.64 255.255.255.0 1500
portcfg ipif ge2 create 192.168.2.64 255.255.255.0 1500
portcfg ipif ge3 create 192.168.3.64 255.255.255.0 1500
portcfg ipif ge4 create 192.168.4.64 255.255.255.0 1500
portcfg ipif ge5 create 192.168.5.64 255.255.255.0 1500
```

2. Create the FCIP tunnel using the **portcfg fciptunnel** command. Note that the following example creates an empty tunnel with hardware compression enabled to which you will add circuits. Note that FCIP tunnels are represented in the switch as VE_Ports. There are several ways to create this tunnel as shown by the following options:

- To create the tunnel with hardware compression, use the following commands.

Site A

```
portcfg fciptunnel 16 create -c 1
```

Site B

```
portcfg fciptunnel 16 create -c 1
```

- To use this tunnel for FICON traffic with hardware compression, create it with the following commands.

Site A

```
portcfg fciptunnel 16 create --ficon -c 1
```

Site B

```
portcfg fciptunnel 16 create --ficon -c 1
```

- To use this tunnel for FCP with Fastwrite and Open Systems Tape Pipelining traffic, and hardware compression, create it using the following commands.

Site A

```
portcfg fciptunnel 16 create --fastwrite --tape-pipelining -c 1
```

Site B

```
portcfg fciptunnel 16 create --fastwrite --tape-pipelining -c 1
```

NOTE

To use software compression (only mode 2 would be valid for a 6 Gb Tunnel), specify “-c 2” instead of “-c 1” in the preceding commands.

At this time, the tunnel has been created with the compression mode, and operational mode defined. The tunnel is not usable yet. You must add circuits to the tunnel. The next step is to create the circuits.

2 Creating a multicircuit tunnel (example)

3. Add circuits using the **portcfg fcipcircuit** command. The command requires the source and destination IP addresses that you assigned to ports in step 1, as well as a bandwidth assignments. The following example commands create six circuits for the FCIP tunnel that you created in step 2. Each circuit provides a fixed 1000 Mbps (1 Gigabit) maximum usable bandwidth.

Site A

```
Site A:
portcfg fcipcircuit 16 create 0 192.168.0.64 192.168.0.63 -b 1000000 -B
1000000

portcfg fcipcircuit 16 create 1 192.168.1.64 192.168.1.63 -b 1000000 -B
1000000

portcfg fcipcircuit 16 create 2 192.168.2.64 192.168.2.63 -b 1000000 -B
1000000

portcfg fcipcircuit 16 create 3 192.168.3.64 192.168.3.63 -b 1000000 -B
1000000

portcfg fcipcircuit 16 create 4 192.168.4.64 192.168.4.63 -b 1000000 -B
1000000

portcfg fcipcircuit 16 create 5 192.168.5.64 192.168.5.63 -b 1000000 -B
1000000
```

Site B

```
portcfg fcipcircuit 16 create 0 192.168.0.63 192.168.0.64 -b 1000000 -B
1000000

portcfg fcipcircuit 16 create 1 192.168.1.63 192.168.1.64 -b 1000000 -B
1000000

portcfg fcipcircuit 16 create 2 192.168.2.63 192.168.2.64 -b 1000000 -B
1000000

portcfg fcipcircuit 16 create 3 192.168.3.63 192.168.3.64 -b 1000000 -B
1000000

portcfg fcipcircuit 16 create 4 192.168.4.63 192.168.4.64 -b 1000000 -B
1000000

portcfg fcipcircuit 16 create 5 192.168.5.63 192.168.5.64 -b 1000000 -B
1000000
```

4. To display the results of creating the tunnel and circuits from the preceding steps, use the **portshow fciptunnel all -c** command. Tunnel status for Site A and Site B displays the same.

```
portshow fciptunnel all -c
switch63:root> portshow fciptunnel all -c
-----
--
Tunnel Circuit OpStatus  Flags    Uptime  TxMBps  RxMBps  ConnCnt  CommRt  Met
-----
--
16      -           Up       c-----  4m22s   0.00    0.00    1        -       -
16      0 ge0       Up       ---4---s  4m22s   0.00    0.00    1  1000/1000  0
```

```

16      1 ge1      Up      ---4--s    4m12s    0.00    0.00    1  1000/1000  0
16      2 ge2      Up      ---4--s    4m2s     0.00    0.00    1  1000/1000  0
16      3 ge3      Up      ---4--s    3m50s    0.00    0.00    1  1000/1000  0
16      4 ge4      Up      ---4--s    3m34s    0.00    0.00    1  1000/1000  0
16      5 ge5      Up      ---4--s    2m10s    0.00    0.00    1  1000/1000  0
-----
--
Flags:  tunnel:  c=compression m=moderate compression a=aggressive compression
           A=Auto compression f=fastwrite t=Tapepipelining F=FICON
           T=TPerf i=IPSec l=IPSec Legacy
Flags:  circuit: s=sack v=VLAN Tagged x=crossport 4=IPv4 6=IPv6
           L=Listener I=Initiator

```

Modifying an FCIP tunnel on a Brocade 7800 FX8-24 blade

FCIP tunnel characteristics and options can be modified as needed, using the `portCfg fcipTunnel` command with the `modify` option. The command syntax is as follows:

```
portCfg fcipTunnel ve_port modify <options>
```

Where:

ve_port Each tunnel is assigned to a specific VE_Port. The VE_Port number serves as the tunnel ID. The range is 16 through 23 for a 7800 switch and 12 through 31 for the FX8-24 blade.

<options> Options are as listed and described in [Table 7](#) on page 40.

NOTE

When you use `portcfg fcipTunnel` to modify the circuit options, the changes apply only to circuit 0.



CAUTION

Using the `modify` option may disrupt traffic on the specified FCIP tunnel for a brief period of time.

Modifying an FCIP circuit on a Brocade 7800 FX8-24 blade

FCIP circuit characteristics and options can be modified as needed, using the `portCfg fcipcircuit` command with the `modify` option. The general command syntax is as follows:

```
portCfg fcipcircuit ve_port modify circuit_id <options>
```

Where:

ve_port Each FCIP tunnel is assigned to a specific VE_Port. The VE_Port number serves as the tunnel ID. Specify the VE_Port of the tunnel that contains the FCIP circuit you want to modify.

circuit_id The numeric ID assigned when the circuit was created.

<options> Options are as listed and described in [Table 8](#) on page 42.

2 Deleting an IP interface on a Brocade 7800 FX8-24 blade

NOTE

You can modify all circuits, including circuit 0, using the **portcfg fcipcircuit** command.

For full details on syntax and using this command, refer to the *Fabric OS Command Reference Manual*.

Deleting an IP interface on a Brocade 7800 FX8-24 blade

You can delete an IP interface using the **portcfg ipif** command with the **delete** option. The command syntax is as follows:

```
portcfg ipif [<slot>/]ge<n> delete <ipaddr>
```

For full details on syntax and using this command, refer to the *Fabric OS Command Reference Manual*.

NOTE

You cannot delete an IP interface if there is a tunnel or circuit configured to use it. Be sure to delete all tunnels and circuits using an interface before deleting it.

Deleting an IP route on a Brocade 7800 FX8-24 blade

You can delete an IP route to a gateway destination IP address using the **portcfg iproute** command with the **delete** option. The command syntax is as follows for both IPv4 and IPv6 addressing:

```
portcfg iproute [<slot>/]ge<n> delete <dest_ipv4> <netmask>
```

```
portcfg iproute [<slot>/]ge<n> delete <dest_ipv6>/<prefix_len>
```

For full details on syntax and using this command, refer to the *Fabric OS Command Reference Manual*.

NOTE

You cannot delete an IP route if there is a tunnel or circuit configured to use it. Be sure to delete all tunnels and circuits using an IP route before deleting it.

Deleting an FCIP tunnel on a Brocade 7800 FX8-24 blade

When you delete an FCIP tunnel, you also delete all associated FCIP circuits. Use the **portCfg fciptunnel** command with the **delete** option to delete FCIP tunnels. The command syntax is as follows:

```
portcfg fciptunnel ve_port delete
```

For full details on syntax and using this command, refer to the *Fabric OS Command Reference Manual*.

**CAUTION**

The `fciptunnel delete` command does not prompt you to verify your deletion. Be sure you want to delete the tunnel before you press Enter.

Deleting an FCIP circuit on a Brocade 7800 FX8-24 blade

You can delete individual FCIP circuits using the `portCfg fcipcircuit` command with the `delete` option. The command syntax is as follows:

```
portcfg fcipcircuit ve_port delete circuit_id
```

For full details on syntax and using this command, refer to the *Fabric OS Command Reference Manual*.

Virtual Fabrics and the Brocade 7800 FX8-24 blade

The 1GbE ports, 10GbE ports, and VE_Ports on the FX8-24 blade can be part of any logical switch, and can be moved between any two logical switches. In addition, ports do not need to be offline when they are moved. However, because GbE ports and VE_Ports are independent of each other, both must be moved in independent steps, and you must delete the configuration on VE_Ports and GbE ports before moving them between logical switches. This differs from the FR4-18i blade, where when GbE ports are moved, all the VE_Ports created on that GbE port are automatically moved, and configurations do not need to be deleted.

NOTE

Virtual fabrics are not supported on the 7800 switch.

Port sharing

In Fabric OS v 7.0 and later, VE_Ports in different logical switches can share a single GbE port (1GbE or 10GbE) on the default switch.

NOTE

In prior Fabric OS versions, in order to use a GbE port for an FCIP tunnel, that port needed to be in the same logical switch as the VE_Port for the tunnel.

With GbE port sharing, you can have the following configuration, as an example:

- Default switch has port GbE0
- Logical switch 1 has VE13, which has a circuit over GbE0
- Logical switch 2 has VE14, which also has a circuit over GbE0

All of the committed-rate restrictions and bandwidth sharing of the GbE ports for ARL remain the same for shared ports in the logical switches. VE_Ports created from shared GbE ports initiate as regular VE ISLs in their respective logical switches.

Limitations of port sharing

Note the following limitations of port sharing:

- Only GbE ports in the default switch can be shared by VE_Ports in different logical switches. A GbE port in a non-default switch can only be used by VE_Ports in that same logical switch.
- The GbE ports in other logical switches or ports on the base switch cannot be shared by ports in different logical switches.
- Tunnels created with a mix of dedicated ports (ports within the same logical switch) and shared ports (ports in the default switch) are not supported.

FCIP on the FR4-18i Blade

In this chapter

- FR4-18i blade 54
- FCIP design considerations for the FR4-18i blade 55
- FCIP services license 57
- QoS implementation over FCIP 57
- IPsec implementation over FCIP 58
- Virtual Fabrics and FCIP 62
- Options for enhancing tape I/O performance 63
- FCIP services configuration guidelines 66
- Setting persistently disabled ports 67
- Configuring VEX_Ports 67
- Creating IP interfaces and routes 67
- Creating an FCIP tunnel 69
- Verifying the FCIP tunnel configuration on the Brocade FR4-18i 69
- Enabling persistently disabled ports on the Brocade 7500 FR4-18i 70
- Managing FCIP tunnels 70
- Managing the VLAN tag table 72

FR4-18i blade

Fabric OS v 7.0 and later supports SAN extension between Brocade FR4-18i blades installed on Brocade DCX Data Center Backbone directors. The Brocade FR4-18i blade has 16 physical Fibre Channel ports and 2 physical GbE ports, as illustrated in [Figure 14](#).

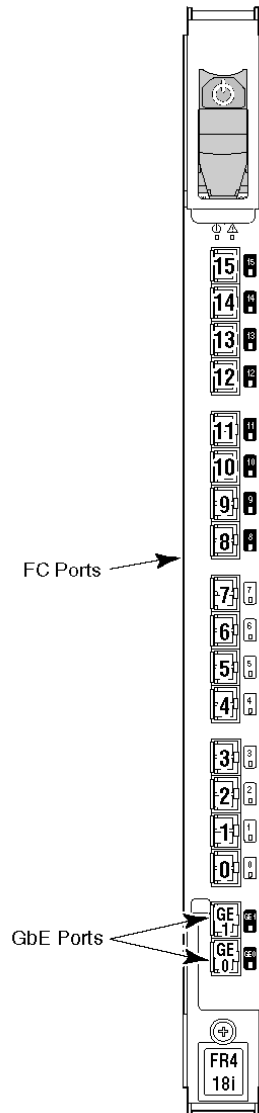

FIGURE 14 FR4-18i port numbering

FR4-18i blade ports

Each Brocade FR4-18i blade presents 16 FC ports and 16 virtual ports. Each GbE interface can support up to eight FCIP tunnels which are represented as eight virtual ports on ge0 and 8 virtual ports on ge1. The mapping of tunnels on ge0 and ge1 to virtual port numbers is represented in [Table 9](#).

TABLE 9 FR4-18i blade tunnel and virtual port numbering

GbE ports	Tunnels	Virtual ports
ge0	0	16
	1	17
	2	18
	3	19
	4	20
	5	21
	6	22
	7	23
ge1	0	24
	1	25
	2	26
	3	27
	4	28
	5	29
	6	30
	7	31

FCIP design considerations for the FR4-18i blade

The following are general design considerations when configuring the Brocade FR4-18i blade:

- The Brocade FR4-18i blade can have up to eight tunnels per GbE interface.
- Source and destination IP addresses are defined on the FCIP tunnel. FCIP circuits are not supported; therefore, FCIP trunking is also not supported.
- If the source and destination IP addresses are not on the same subnet, an IP static route must be defined.
- FCIP is not supported through Network Address Translation (NAT).
- When an FR4-18i blade is installed on a DCX that includes FC8-64 blades, ports 0 through 55 of the FC8-64 blade can route to FR4-18i VE_Ports and vice versa, but ports 56 through 63 cannot route to FR4-18i VE_Ports. If ports 56 through 63 and FR4-18i VE_Ports are on the default switch or on the same logical switch in a Virtual Fabrics (VF) configuration, those ports will not be able to send traffic between each other. There are no general restrictions regarding FR4-18i blades and FC8-64 blades coexisting in the same chassis. Furthermore, there are no specific coexistence restrictions in the same chassis if ports 56 through 63 of the FC8-64 blade and the FR4-18i blade VE_Ports are on different logical switches or not part of the default switch and therefore are not allowed to route to each other. This restriction does not apply to the DCX-4S. On a DCX-4S, ports 0 through 63 of the FC8-64 blade can route to FR4-18i VE_Ports and vice versa.
- The FR4-18i and FX8-24 blades cannot be supported in the same chassis using Fabric OS v7.0 and later.

Virtual port types

Virtual ports may be defined as VE_Ports or VEX_Ports:

- VE_Ports (virtual E_Ports) are used to create interswitch links (ISLs) through an FCIP tunnel. If VE_Ports are used on both ends of an FCIP tunnel, the fabrics connected by the tunnel are merged.
- VEX_Ports enable FC-FC Routing Service functionality over an FCIP tunnel. VEX_Ports enable interfabric links (IFLs). If a VEX_Port is on one end of an FCIP tunnel, the fabrics connected by the tunnel are not merged. The other end of the tunnel must be defined as a VE_Port. VEX_Ports are not used in pairs.

Figure 15 illustrates a portion of a Fibre Channel network that uses FCIP ISLs, which are VE_Ports connected over the IP WAN network, to join the office and data center SANs into a single larger SAN.

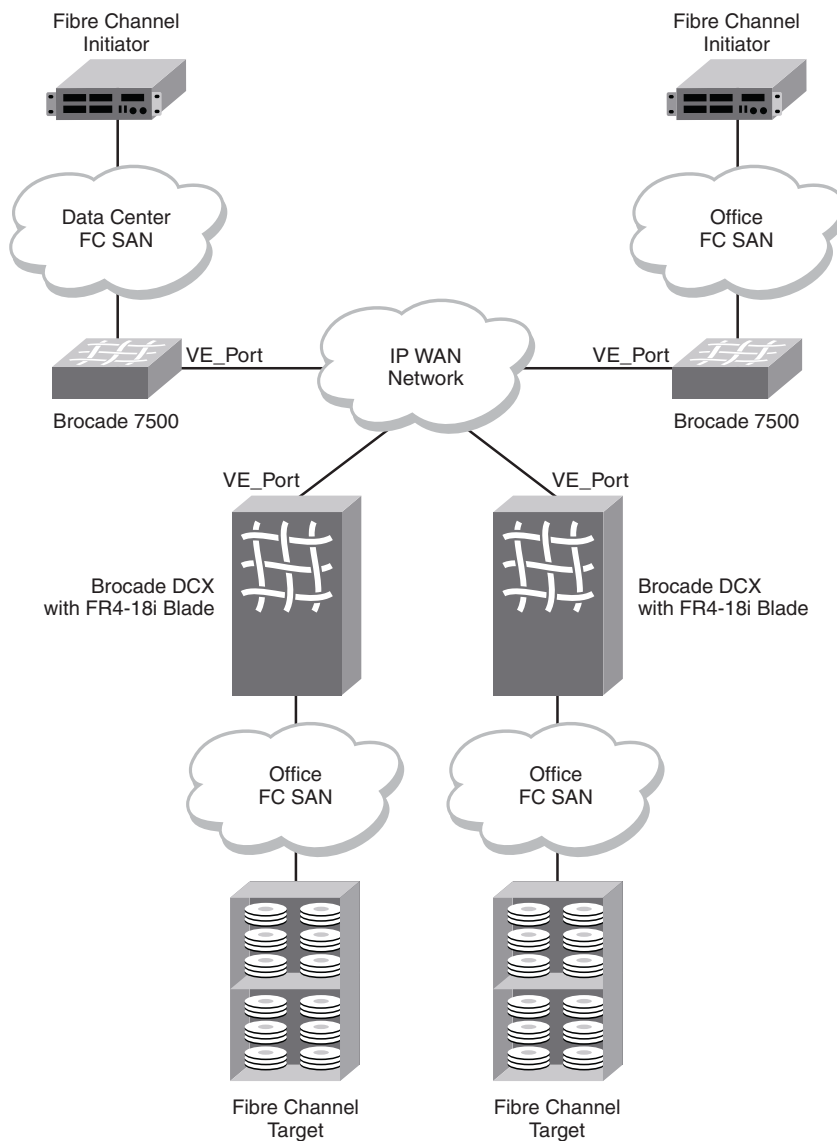

FIGURE 15 Network using FCIP

Compression on FCIP tunnels

Data compression can be enabled or disabled on FCIP tunnels. The default setting is to disable compression.

Traffic shaping

Traffic can be shaped by establishing a rate limit per tunnel. A committed rate guarantees a fixed amount of bandwidth and is assigned to a tunnel. The committed rate setting ensures that an FCIP tunnel operates at the specific fixed rate for FCIP traffic. The rest of the possible 1000 Mbps rate that a GE interface provides is available to other tunnels created on this GE interface. If the committed rate is too small for the amount of FCIP traffic, the FCIP tunnel is limited to that rate and performance may be affected. Total bandwidth of all committed and uncommitted rate tunnels must not exceed 1000 Mbps. When allocating committed rates to tunnels, do not allocate more bandwidth than the WAN can support or your FCIP tunnel may not be stable.

FCIP services license

Most of the FCIP extension services described in this chapter require the Brocade High Performance Extension over FCIP/FC license. Use the **licenseShow** command to verify the license is present on the hardware used on both ends of the FCIP tunnel.

QoS implementation over FCIP

Refer to [“QoS, DSCP, and VLANs”](#) on page 24 for a definition of QoS policies.

Fabric OS versions 6.0.0 and later provide for Fibre Channel QoS through internal QoS priorities. Those priorities can be mapped to TCP/IP network priorities. There are two options for TCP/IP network-based QoS:

- Layer 3 Differentiated Services Code Point (DSCP).
- VLAN tagging and Layer 2 Class of Service (L2CoS).

DSCP Quality of Service

Refer to [“DSCP Quality of Service”](#) on page 24 for a definition of Quality of Service (QoS).

DSCP settings are useful only if IP routers are configured to enforce QoS policies uniformly within the network. IP routers use the DSCP value as an index into a Per Hop Behavior (PHB) table. Control connections and data connections may be configured with different DSCP values. Before configuring DSCP settings, determine if the IP network you are using implements PHB, and consult with the network administrator to determine the appropriate DSCP values.

L2CoS Quality of Service

Refer to “[VLANs and Layer 2 Quality of Service](#)” on page 24 for a definition of Layer 2 Class of Service (L2CoS).

A VLAN is a virtual LAN network. A VLAN may reside within a single physical network, or it can span several physical networks. Related devices and applications that are separated by physical LAN boundaries can reside in the same VLAN. Also, a large physical network can be broken down into smaller VLANs. VLAN traffic is routed using 802.1Q-compliant tags within an Ethernet frame. The tag includes a unique VLAN ID, and Class of Service (CoS) priority bits. The CoS priority scheme (also called Layer 2 Class of Service or L2CoS), uses only the upper 3 bits of the TOS field, allowing eight priorities.

When both DSCP and L2CoS are used

If an FCIP tunnel is not VLAN tagged, only DSCP is relevant. If the FCIP tunnel is VLAN tagged, both DSCP and L2CoS are relevant, unless the VLAN is end-to-end, with no intermediate hops in the IP network. [Table 4](#) on page 25 shows the default mapping of DSCP priorities to L2CoS priorities per tunnel ID. This may be helpful when consulting with the network administrator. These values may be modified per FCIP tunnel.

IPsec implementation over FCIP

Refer to “[IPsec implementation over FCIP tunnels](#)” on page 28 for a definition of Internet Protocol security (IPsec).

Used to provide greater security in tunneling on an FR4-18i blade, the IPsec feature does not require you to configure separate security for each application that uses TCP/IP. IPsec works on FCIP tunnels with or without IP compression (IPComp), FCIP Fastwrite, and OSTP.

IPsec requires the High-Performance Extension over FCIP/FC license.

IPsec uses some terms that you should be familiar with before beginning your configuration ([Table 10](#)). These are standard terms, but are included here for your convenience.

TABLE 10 IPsec terminology

Term	Definition
AES	Advanced Encryption Standard. FIPS 197 endorses the Rijndael encryption algorithm as the approved AES for use by US Government organizations and others to protect sensitive information. It replaces DES as the encryption standard.
AES-XCBC	Cipher Block Chaining. A key-dependent one-way hash function (MAC) used with AES in conjunction with the Cipher-Block-Chaining mode of operation, suitable for securing messages of varying lengths, such as IP datagrams.
AH	Authentication Header. Like ESP, AH provides data integrity, data source authentication, and protection against replay attacks but does not provide confidentiality.
DES	Data Encryption Standard is the older encryption algorithm that uses a 56-bit key to encrypt blocks of 64-bit plain text. Because of the relatively shorter key length, it is not a secured algorithm and no longer approved for Federal use.
3DES	Triple DES is a more secure variant of DES. It uses three different 56-bit keys to encrypt blocks of 64-bit plain text. The algorithm is FIPS-approved for use by Federal agencies.

TABLE 10 IPsec terminology (Continued)

Term	Definition
ESP	Encapsulating Security Payload is the IPsec protocol that provides confidentiality, data integrity and data source authentication of IP packets, and protection against replay attacks.
IKE	Internet Key Exchange is defined in RFC 2407, RFC 2408 and RFC 2409. IKEv2 is defined in RFC 4306. IKE uses a Diffie-Hellman key exchange to set up a shared session secret, from which cryptographic keys are derived and communicating parties are authenticated. The IKE protocol creates a security association (SA) for both parties.
MD5	Message Digest 5, like SHA-1, is a popular one-way hash function used for authentication and data integrity.
SHA	Secure Hash Algorithm, like MD5, is a popular one-way hash function used for authentication and data integrity.
MAC	Message Authentication Code is a key-dependent, one-way hash function used for generating and verifying authentication data.
HMAC	A stronger MAC because it is a keyed hash inside a keyed hash.
SA	Security Association is the collection of security parameters and authenticated keys that are negotiated between IPsec peers.

Limitations using IPsec over FCIP tunnels

The following limitations apply to using IPsec:

- IPsec can only be configured on IPv4-based tunnels.
- Network Address Translation (NAT) is not supported.
- Authentication Header (AH) is not supported.
- You can only create a single secure tunnel on a port; you cannot create a nonsecure tunnel on the same port as a secure tunnel.
- IPsec-specific statistics are not supported.
- To change the configuration of a secure tunnel, you must delete the tunnel and recreate it.
- Jumbo frames are not supported for IPsec.
- There is no RAS message support for IPsec.
- Only a single route is supported on an interface with a secure tunnel.
- Secure tunnels cannot be created on a Brocade FR4-18i blade if any IPv6 addresses are defined on either ge0 or ge1.
- Secure tunnels cannot be defined with VLAN Tagged connections.

Configuring IPsec

IPsec requires predefined configurations for IKE and IPsec. You can enable IPsec only when these configurations are well-defined and properly created in advance.

The following describes the sequence of events that invokes the IPsec protocol.

1. Traffic from an IPsec peer with the lower local IP address initiates the IKE negotiation process.
2. IKE negotiates SAs and authenticates IPsec peers, and sets up a secure channel for negotiation of phase 2 (IPsec) SAs.

3. IKE negotiates SA parameters, setting up matching SAs in the peers. Some of the negotiated SA parameters include encryption and authentication algorithms, Diffie-Hellman key exchange, and SA lifetimes.
4. Data is transferred between IPsec peers based on the IPsec parameters and keys stored in the SA database.
5. IPsec tunnel termination. SA lifetimes terminate through deletion or by timing out.

All of these steps require that the correct policies have been created. Because policy creation is an independent procedure from FCIP tunnel creation, you must know which IPsec configurations have been created. This ensures that you choose the correct configurations when you enable an IPsec tunnel.

The first step to configuring IPsec is to create a policy for IKE and a policy for IPsec. Once the policies have been created, you assign the policies when creating the FCIP tunnel.

IKE negotiates SA parameters and authenticates the peer using the preshared key authentication method. Once the two phases of the negotiation are completed successfully, the actual encrypted data transfer can begin.

IPsec policies are managed using the **policy** command.

You can configure up to 32 IKE and 32 IPsec policies. Policies cannot be modified; they must be deleted and recreated in order to change the parameters. You can delete and recreate any policy as long as the policy is not being used by an active FCIP tunnel.

Each FCIP tunnel is configured separately and may have the same or different IKE and IPsec policies as any other tunnel. Only one IPsec tunnel can be configured for each GbE port.

IPsec parameters

When creating policies, the parameters listed in [Table 11](#) are fixed and cannot be modified.

TABLE 11 Fixed policy parameters

Parameter	Fixed Value
IKE negotiation protocol	Main mode
ESP	Tunnel mode
IKE negotiation authentication method	Preshared key
3DES encryption	Key length of 168 bits
AES encryption	Key length of 128 or 256

The parameters listed in [Table 12](#) can be modified.

TABLE 12 Modifiable policy parameters

Parameter	Description
Encryption Algorithm	3DES—168-bit key AES-128—128-bit key (default) AES-256—256-bit key
Authentication Algorithm	SHA-1—Secure Hash Algorithm (default) MD5—Message Digest 5 AES-XCBC—Used only for IPsec

TABLE 12 Modifiable policy parameters (Continued)

Parameter	Description
Security Association lifetime in seconds	Security association lifetime in seconds. A new key is renegotiated before seconds expires. seconds must be between 28800 to 250000000 or 0. The default is 28800.
PFS (Perfect Forward Secrecy)	Applies only to IKE policies. Choices are On/Off and default is On.
Diffie-Hellman group	Group 1–768 bits (default) Group 14–2048 bits

Creating an IKE and IPsec policy

For a complete description of the **policy** command, refer to the *Fabric OS Command Reference Manual*.

1. Connect to the switch and log in using an account assigned to the admin role.
2. Enter the **policy** command to create IKE and IPsec policies:

```
policy --create type number [-enc encryption_method] [-auth authentication_algorithm] [-pfs off|on] [-dh DH_group] [-seclife secs]
```

The following example shows how to create IKE policy number 10 using 3DES encryption, MD5 authentication, and Diffie-Hellman Group 1:

```
switch:admin> policy --create ike 10 -enc 3des -auth md5 -dh 1
```

For full details on syntax and using this command, refer to the *Fabric OS Command Reference Manual*.

Displaying IKE and IPsec policy settings

1. Connect to the switch and log in using an account assigned to the administrative role.
2. Display the settings for a single policy by entering the following command:

```
policy --show type number
```

For example, to view the IPsec 1 policy, enter the following command.

```
policy --show ipsec 1
```

3. Display the policy settings for all defined policies by entering the following command:

```
policy --show type all
```

For full details on syntax and using this command, refer to the *Fabric OS Command Reference Manual*.

Deleting an IKE and IPsec policy

Policies cannot be modified. You must delete and then recreate a policy with the new parameters.

1. Connect to the switch and log in using an account assigned to the admin role.

2. Enter the following command.

```
policy --delete type number
```

In the syntax, *type* is the policy type and *number* is the number assigned.

For example, to delete the IPsec policy number 10:

```
switch:admin> policy --delete ipsec 10  
The policy has been successfully deleted.
```

Viewing IPsec information for an FCIP tunnel

1. Connect to the switch and log in using an account assigned to the admin role.
2. Enter the **portShow fcipTunnel** command.

The following example shows the **portShow fcipTunnel** command used to display IPsec information for tunnel 3:

```
switch:admin> portshow fcipTunnel 8/ge0 3 -ipsec
```

NOTE

On the Brocade FR4-18i, the *-ipsec* option displays IKE and IPsec policy information on IPsec-enabled tunnels.

For details of command syntax and output examples, refer to the *Fabric OS Command Reference Manual*.

Virtual Fabrics and FCIP

Any GbE port and all of its associated FCIP tunnels on a chassis can be assigned to any logical switch. As with the current Fabric OS, the port types supported by FCIP are either VE_Port or VEX_Port. When a GbE port is moved to a logical switch, all eight VE_Ports and VEX_Ports are automatically moved. There is no interaction required to assign or move them.

The following constraints on VE_Ports and VEX_Ports apply:

- All VEX_Ports will be persistently disabled when Virtual Fabric mode is enabled. You need to create a logical switch with the base switch attribute turned on and move the ports to the new base switch.
- The ports must be offline before they are moved from one logical switch to another.
- A logical switch is independent of the base switch. Therefore, all GbE port-based protocol addresses, such as IP addresses, must be unique within a logical switch.
- FCIP tunnels working as an extended ISL can carry traffic for multiple fabrics. Therefore, a GbE port used as an extended ISL must be assigned to the base switch.

Options for enhancing tape I/O performance

FCIP Fastwrite and Open Systems Tape Pipelining (OSTP) are options available for enhancing open systems SCSI tape write I/O performance. FCIP Fastwrite and OSTP are implemented together.

When the FCIP link is the slowest part of the network, consider using FCIP Fastwrite and OSTP. FCIP Fastwrite and OSTP are two features that provide accelerated speeds for read and write I/O over FCIP tunnels in some configurations:

OSTP accelerates SCSI read and write I/Os to sequential devices (such as tape drives) over FCIP, which reduces the number of round-trip times needed to complete the I/O over the IP network and speeds up the process. To use OSTP, you must also enable FCIP Fastwrite.

Both sides of an FCIP tunnel must have matching configurations for these features to work. FCIP Fastwrite and OSTP are enabled by turning them on during the tunnel configuration process. They are enabled on a per-FCIP tunnel basis. See [“Creating an FCIP tunnel”](#) on page 69 for details.

Consider the constraints described in [Table 13](#) when configuring tunnels to use either of these features.

TABLE 13 Using FCIP Fastwrite and OSTP

FCIP Fastwrite	OSTP
Each GbE port supports up to 2048 simultaneous accelerated exchanges, which means a <i>total of 2048 simultaneous exchanges combined</i> for Fastwrite and OSTP.	Each GbE port supports up to 2048 simultaneous accelerated exchanges, which means a <i>total of 2048 simultaneous exchanges combined</i> for Fastwrite and OSTP.
Does not affect FICON traffic	Does not affect FICON traffic
Does not support multiple equal-cost path configurations (see “FCIP Fastwrite and OSTP configurations”).	Does not support multiple equal-cost path configurations or multiple non-equal-cost path configurations (see “FCIP Fastwrite and OSTP configurations”).
Class 3 traffic is accelerated with Fastwrite.	Class 3 traffic is accelerated between host and sequential device. With sequential devices (tape drives), there are 1024 initiator-tape (IT) pairs per GbE port, but 2048 initiator-tape-LUN (ITL) pairs per GbE port. The ITL pairs are shared among the IT pairs. For example, there are two ITL pairs for each IT pair as long as the target has two LUNs. If a target has 32 LUNs, there are 32 ITL pairs for IT pairs. In this case, only 64 IT pairs are associated with ITL pairs. The rest of the IT pairs are not associated to any ITL pairs, so OSTP is not performed for those pairs. By default, only Fastwrite-based acceleration is performed on the non-associated pairs.
	Does not support multiple non-equal-cost path between host and sequential device

FCIP Fastwrite and OSTP configurations

To help understand the supported configurations, consider the configurations shown in the two figures below. In both cases, there are no multiple equal-cost paths. In [Figure 16](#), there is a single tunnel with Fastwrite and OSTP enabled. In the [Figure 17](#), there are multiple tunnels, but none of them create a multiple equal-cost path.

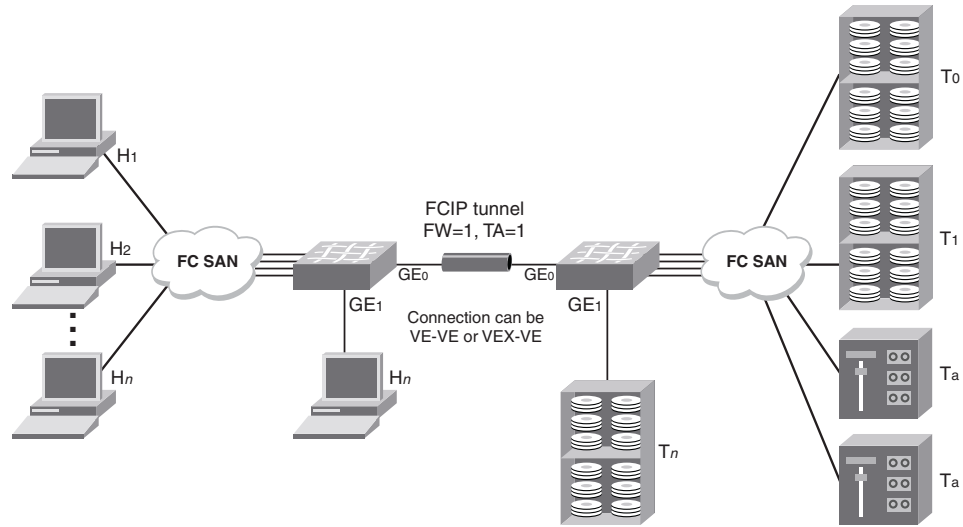

FIGURE 16 Single tunnel, Fastwrite and OSTP enabled

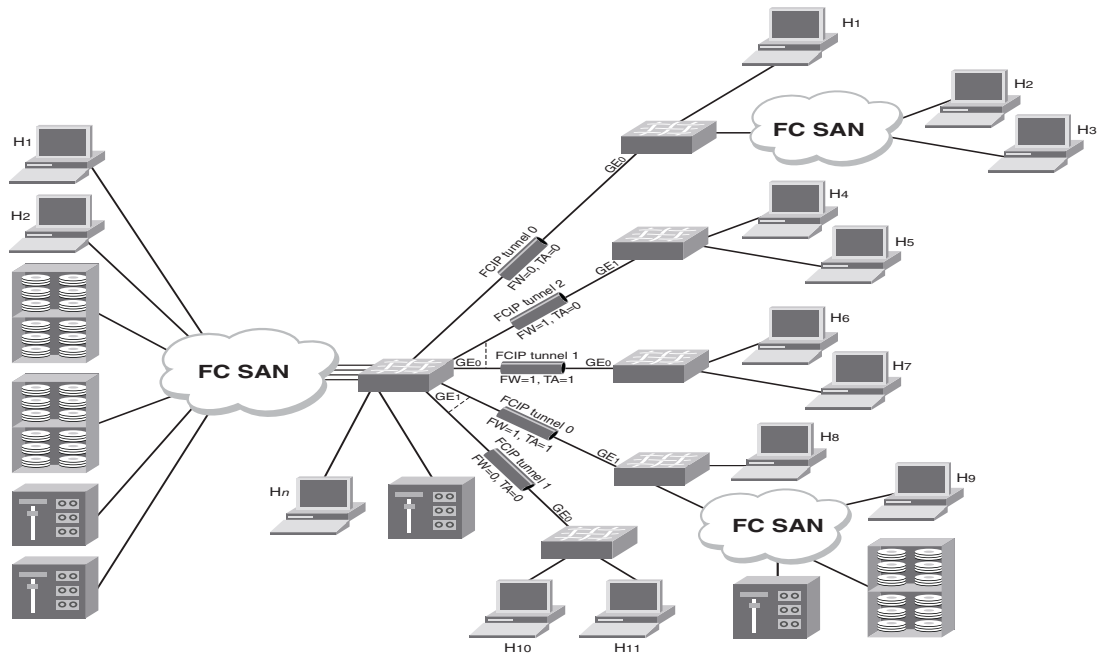

FIGURE 17 Multiple tunnels to multiple ports, Fastwrite and OSTP enabled on a per-tunnel/per-port basis

Unsupported configurations for Fastwrite and OSTP

Configurations illustrated in [Figure 18](#) are not supported with Fastwrite and OSTP. These configurations use multiple equal-cost paths.

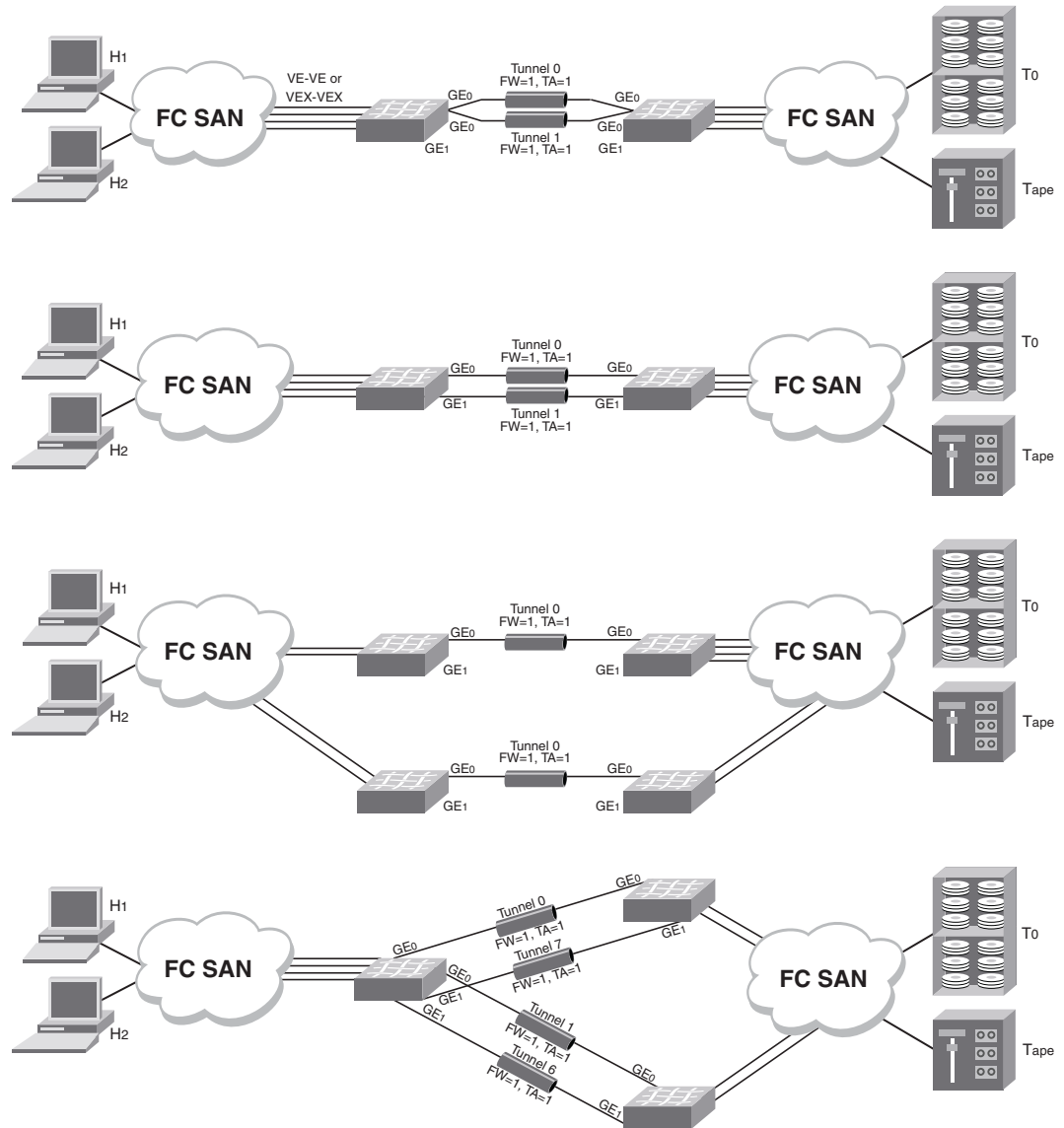

FIGURE 18 Unsupported configurations with Fastwrite and OSTP

FCIP services configuration guidelines

There are multiple configuration requirements and options associated with FCIP services. The following general guidelines may be helpful. The steps are presented in an order that minimizes the number of times ports need to be disabled and enabled. In practice, the steps do not have to be taken in this order.

1. Determine if you are implementing IPsec.

IPsec configuration may be done at any time, but defining IPsec policies first ensures that they will be available when FCIP tunnels are configured. Refer to [“Configuring IPsec”](#) for specific instructions.
2. Determine which FCIP tunnel you want to configure.

Each FCIP tunnel is associated with a specific virtual port, and a specific Ethernet port, as shown in [Table 9](#) on page 55. For example, if you want to configure FCIP tunnel 0, you need to configure virtual port 16, and define an IP interface and one or more IP routes over ge0.
3. Persistently disable the VE_Ports before you configure them.

Ports on a new Brocade FR4-18i blade are persistently disabled by default. On a Brocade FR4-18i blade that has already been installed and configured, check the EX_Port status using the **portCfgShow** command, and persistently disable the ports using the **portCfgPersistentDisable** command before you configure them. Refer to [“Setting persistently disabled ports”](#) for a description.
4. Determine if any of the virtual ports should be VEX_Ports, and configure them using the **portCfgVEXPort** command. Refer to [“Configuring VEX_Ports”](#) for specific instructions.
5. Create an IP interface using the **portCfg ipif** command. Refer to [“Creating IP interfaces and routes”](#) for specific instructions.
6. Create one or more IP routes using the **portCfg iproute** command. Refer to [“Creating IP interfaces and routes”](#) for specific instructions.
7. If you are implementing VLAN tagging, configure static ARP entries for the IP interfaces on both ends of the tunnel using the **portCfg arp** command. Refer to [“Creating IP interfaces and routes”](#) for specific instructions.
8. Test the IP connection using the **portCmd --ping** command. Refer to [“Creating IP interfaces and routes”](#) for specific instructions.
9. Create an FCIP tunnel using the **portCfg fciptunnel** command. Refer to [“Creating an FCIP tunnel”](#) on page 69 for specific instructions.
10. If you are implementing FICON emulation, configure FICON emulation using the **portCfg ficon** command. Refer to the *Fabric OS FICON Administrator's Guide* for specific instructions.
11. If you are implementing FTRACE, configure FTRACE using the **portCfg ftrace** command.
12. Check the configuration to ensure that the parameters are correct using the **portShow fciptunnel** command.
13. Persistently enable the VE_Ports using the **portCfgPersistentEnable** command.
14. Create the same configuration on the Brocade FR4-18i blade at the other end of the tunnel.

Setting persistently disabled ports

Ports used on an FCIP tunnel must be persistently disabled before you can configure FCIP tunnels. You must change their state from persistently enabled to persistently disabled. Once the FCIP tunnels have been fully configured on both ends of the tunnel, you can persistently enable the ports.

1. Enter the **portCfgShow** command to view ports that are persistently disabled.
2. Enter the **portCfgPersistentDisable** command to disable any ports that you will use in the FCIP tunnel configuration.

Configuring VEX_Ports

If you are going to use a VEX_Port in your tunnel configuration, use the **portCfgVEXPort** command to configure the port as a VEX_Port. Remember that a VEX_Port must be paired with a VE_Port. VEX_Ports cannot communicate with other VEX_Ports.

1. Connect to the switch and log in using an account assigned to the admin role.
2. Enter the **portCfgVEXPort** command to configure a port to a VEX_Port. T

```
portCfgVEXPort [slot/]portnumber [ge0|ge1] [-a 1|2] [-f fabricid] [-r ratov] [-e edtov]
[-d domainid] [-p 1|2|3] [-t 1|2]
```

Refer to the *Fabric OS Command Reference Manual* for full details on **portCmd --ping** command syntax.

The following example configures a port as a VEX_Port for slot number 8 in port number 18, enables admin, and specifies fabric ID 2 and preferred domain ID 220:

```
switch:admin> portcfgvlexport 8/18 -a 1 -f 2 -d 220
```

Creating IP interfaces and routes

The IP network connection between two FR4-18i blades is configured by defining IP interfaces for origin and destination virtual ports, and then defining one or more IP routes to connect them.

1. Define the IP interface of each virtual port, using the **portCfg** command. You can define up to eight IP interfaces per GbE port.

```
portCfg ipif [slot/]ge0|ge1 create src_ipaddr mtu_size
```

Refer to the *Fabric OS Command Reference Manual* for full details on **portCmd --ping** command syntax.

By default, the virtual ports will automatically become VE_Ports.

2. Define IP routes on a GbE port. After defining the IP interface of the remote switch, you can define destination routes on an interface. You can specify a maximum of 32 routes per GbE port using the following command:

```
portCfg iproute [slot/]ge0|ge1 create dest_ipaddr gateway_router [metric]
```

NOTE

Refer to the *Fabric OS Command Reference Manual* for full details on command syntax.

The following example shows two routes being added to an interface:

```
switch:admin06> portcfg iproute 8/ge0 create 192.168.11.0 255.255.255.0
192.168.100.1 1
switch:admin06> portcfg iproute 8/ge0 create 192.168.12.0 255.255.255.0
192.168.100.1 1
```

The following example verifies that the two routes have been successfully created:

```
switch:admin06> portshow iproute 8/ge0

Slot: 8 Port: ge0
IP Address      Mask           Gateway        Metric  Flags
-----
192.168.100.0  255.255.255.0  192.168.100.40  0       Interface
192.168.100.0  255.255.255.0  192.168.100.41  0       Interface
192.168.11.0   255.255.255.0  192.168.100.1   1
192.168.12.0   255.255.255.0  192.168.100.1   1
```

3. If you are implementing VLAN tagging, create a static ARP entry for the IP interfaces on both ends of the tunnel, using the **portCfg arp** command with the **add** option. The command syntax is as follows.

```
portCfg arp [slot/]ge0|ge1 add ipaddr macaddr
```

You can obtain the MAC address (*macaddr*) by using the **portShow arp** command with the **-lmac** option.

4. Verify IP connectivity by entering the **portCmd --ping** command to test the connection to a destination IP address from a source IP address on one of the local Ethernet ports (Ge0 or Ge1). This verification also ensures that data packets can be sent to the remote interface. You can test a connection only if both ports have IP interfaces set. Refer to the *Fabric OS Command Reference Manual* for full details on **portCmd --ping** command syntax.

General command syntax is as follows.

```
portCmd --ping [slot/]ge0|ge1 [-s source_ip] [-d dest_ip] [-c L2 class-of-service]
[-n num-requests] [-q type-of-service] [-t ttl] [-v vlan tag] [-w wait-time] [-z size]
```

For details of command syntax and output examples, refer to the *Fabric OS Command Reference Manual*.

The following example tests the connection between 192.175.5.100 and 192.175.5.200,

```
switch:admin06> portcmd --ping ge0 -s 192.175.5.100 -d 192.175.5.200
```

5. Test end-to-end IP path performance using WAN analysis tools (optional, may be done at any time).

NOTE

The general recommendation is to run **ipPerf** only when there are no active tunnels on the IP network. For more information, refer to [“The ipperf option”](#) on page 82.

Creating an FCIP tunnel

After you have verified licensing and connectivity between source and destination IP interfaces, you can configure FCIP tunnels. As you plan the tunnel configurations, be aware that uncommitted rate tunnels use a minimum of 1000 Kbps, up to a maximum of available uncommitted bandwidth on the GbE port. The total bandwidth available on a GbE port is 1 Gbps. You can configure tunnels as bidirectional entities with different commit rates in both directions.

NOTE

You cannot create FCIP tunnels that connect to a Brocade Multiprotocol Router Model AP7420.

Create an FCIP tunnel using the **portCfg fciptunnel** command. Following is the general syntax for this command:

```
portCfg fciptunnel [slot/]ge0|ge1 create tunnel_id remote_ip_addr local_ip_addr
comm_rate[-b] [-c] [-s] [-f] [-t] [-M] [-n remote_wwn] [-k timeout] [-r
retransmissions] [-m time] [-q control_dscp] [-Q data_dscp] [-v vlan_id] [-p
control_L2CoS] [-P data_L2CoS] [-ike ike_number] [-ipsec ipsec_number] [-key
preshared_key] [-d description]
```

Refer to the *Fabric OS Command Reference Manual* for command syntax and details on using this command. Command syntax and arguments are different for the 7800 switch, FR4-18i blade, and FX8-24 blade.

1. Connect to the switch and log in using an account assigned to the admin role.
2. Create an FCIP tunnel using the `portCfg fciptunnel` command. The command syntax is as follows.

For full details on syntax and using this command, refer to the *Fabric OS Command Reference Manual*.

Example of creating an FCIP tunnel

The following example creates one end of a tunnel over ge0 between remote IP address 192.168.10.1 and local IP address 192.168.20.1 with a tunnel id of 0, over VLAN 100, with a layer 2 class of service of 3 for control traffic (-p 3 operand), and a layer 2 class of service of 7 (-P 7 operand) for data traffic.

```
portcfg fciptunnel 8/ge0 create 2 192.168.10.1 192.168.20.1 0 -v 100 -p 3 -P 7
```

Example of creating an FCIP tunnel with FastWrite and OSTP enabled

The following example creates an FCIP tunnel with FastWrite (-f operand) and OSTP (-t operand) enabled.

```
switch:admin> portcfg fciptunnel ge1 create 1 192.168.1.2 192.168.1.201 0 -f -t
```

Verifying the FCIP tunnel configuration on the Brocade FR4-18i

After you have created local and remote FCIP configurations, it is recommended that you verify that the tunnel configuration operation succeeded using the **portShow fcipTunnel** command (be sure to specify the slot/port numbers and the tunnel IDs).

Refer to the *Fabric OS Command Reference Manual* for detailed command syntax and output examples for this command.

3 Enabling persistently disabled ports on the Brocade 7500 FR4-18i

1. Connect to the switch and log in using an account assigned to the admin role.
2. Verify the FCIP tunnel using the **portShow fciptunnel** command. The command syntax is as follows.

```
portShow fciptunnel [slot/][ge0|ge1 all|tunnel_id]
```

NOTE

For details of command syntax and output examples, refer to the *Fabric OS Command Reference Manual*.

If IPsec has been enabled and a policy added to the configuration, you will see the policy information under the status section of the output. The policy information is visible only when IPsec is configured, and can be displayed by entering the **portShow fciptunnel <ge_port> all** command.

After FCIP tunnels are created, the configuration is saved in a persistent database. At this point, all configured FCIP tunnels now appear in the fabric as VE_Ports.

3. Verify that the VE_Port or VEX_Port is online using the **switchShow** command.

Enabling persistently disabled ports on the Brocade 7500 FR4-18i

Before an FCIP tunnel can be used, the associated ports must be persistently enabled.

NOTE

VEX_Port Users: If the fabric is already connected, you must leave the ge0 and ge1 ports disabled until *after you have configured the VEX_Port*; this will prevent unintentional merging of the two fabrics.

1. Connect to the switch and log in using an account assigned to the admin role.
2. Enter the **portCfgShow** command to view ports that are persistently disabled.
3. After identifying the ports, enter the **portCfgPersistentEnable** command to enable the ports.
4. Enter the **portCfgShow** command to verify the port is persistently enabled.

Refer to the *Fabric OS Command Reference Manual* for command syntax and details on using this command.

Managing FCIP tunnels

**CAUTION**

Using the modify option disrupts traffic on the specified FCIP tunnel for a brief period of time.

NOTE

IPsec-enabled tunnels cannot be modified, they can only be deleted and then recreated with new options. This is because IPsec key negotiation uses many of the parameter values during secure tunnel initialization.

1. Connect to the switch and log in using an account assigned to the admin role.
2. Enter the **portCfg fciptunnel** command to modify FCIP tunnels. You must specify at least one characteristic to modify. The command syntax is as follows:

```
portCfg fciptunnel [slot/] ge o | ge1 port modify tunnel_id [-b comm_rate] [-c 0|1] [-s 0|1] [-f
0|1] [-M 0|1] [-k timeout] [-m time] [-q control_dscp] [-Q data_dscp] [-p control_L2Cos]
[-P data_L2Cos] [-r retransmissions] [-t 0|1]
```

NOTE

For details of command syntax and output examples, refer to the *Fabric OS Command Reference Manual*.

The following example shows two FCIP tunnels created on slot 8, port ge0; the first with an uncommitted bandwidth (0), and the second with a committed bandwidth of 10000 Kbps:

```
switch:admin> portcfg fciptunnel 8/ge0 create 2 192.168.100.50 192.168.100.40
0
switch:admin06> portcfg fciptunnel 8/ge0 create 3 192.168.100.51
192.168.100.41 10000
```

The following example shows an FCIP tunnel created between a remote interface 10.1.1.44, and a local IP interface 192.168.131.124:

```
switch:admin> portcfg fciptunnel 3/ge0 create 6 10.1.1.44 192.168.131.124
155000
```

Modifying and deleting QoS settings

The **QosMap** option of the **portCfg fciptunnel** command allows you to modify QoS settings or delete the QosMap configuration file for a virtual port without bringing the FCIP tunnel down.

NOTE

Modified values are not reset to defaults when the tunnel QoS is disabled and enabled. If you want to revert to default values, use the **-default** option.

1. Connect to the switch and log in using an account assigned to the admin role.
2. Enter the **portCfg fcipTunnel** command to modify QoS settings on a virtual port. You must specify at least one characteristic to modify. The general command syntax is as follows:

```
portCfg fciptunnel [slot/]ge0|ge1 qosmap tunnel_id -default|-delete|vc_num -Q dscp
-P L2cos
```

For details of command syntax and output examples, refer to the *Fabric OS Command Reference Manual*.

Deleting an FCIP tunnel on a Brocade 7500 FR4-18i

1. Connect to the switch and log in using an account assigned to the admin role.
2. Enter the **portCfg fciptunnel** command to delete FCIP tunnels. The command syntax is as follows.

```
portcfg fciptunnel [slot/]ge0|ge1 delete tunnel_id
```

The following example shows two tunnels deleted on slot 8, port ge0:

3 Managing the VLAN tag table

```
switch:admin> portcfg fciptunnel 8/ge0 delete 6
switch:admin> portcfg fciptunnel 8/ge0 delete 7
```

For full details on syntax and using this command, refer to the *Fabric OS Command Reference Manual*.

Deleting an IP route on a Brocade 7500 FR4-18i

The following command deletes an IP route for a specified IPv4 address.

```
portcfg iproute [slot/]ge0|ge1 delete dest_IPv4_addr netmask
```

For an IPv6 address:

```
portcfg iproute [slot/]ge0|ge1 delete IPv6_addr/prefix_len
```

For full details on syntax and using this command, refer to the *Fabric OS Command Reference Manual*.

Deleting an IP interface on a Brocade 7500 FR4-18i

The following command deletes an IP interface (IPIF).

```
portcfg ipif [slot/]ge0|ge1 delete ipaddr
```

NOTE

You cannot delete an IP interface until after the tunnel and route have been removed,

For full details on syntax and using this command, refer to the *Fabric OS Command Reference Manual*.

Managing the VLAN tag table

To manage the VLAN tag table on a Brocade 7500 FR4-18i, refer to [“Managing the VLAN tag table”](#) on page 26.

FCIP Management and Troubleshooting

In this chapter

• Inband management.....	73
• WAN performance analysis tools	80
• Portshow command usage	85
• FCIP tunnel issues.....	88
• FCIP links	90
• FTRACE concepts.....	91

Inband management

Inband management allows management of a 7800 switch or FX8-24 blade in conjunction with FCIP traffic through GbE ports. This enables a management station located on the WAN side of the FCIP platform to communicate with the control processor (CP) for management tasks, such as SNMP polling, SNMP traps, troubleshooting, and configuration. Through IP forwarding, inband management also allows a management station connected to a LAN through the management port of one 7800 or FX8-24 to manage the 7800 or FX8-24 at the far end of the network through the WAN.

The inband management path is achieved by receiving the management traffic from the GbE port and transmitting the traffic to the CP through a new interface. The CP then handles the management traffic as it would handle any other management requests from a normal management interface. The inband management interface is protocol-independent, so any traffic destined for these inband management interfaces passes through the data processor (DP) to the CP. It is then handled on the CP according to the rules set forth for the normal management interface and follows any security rules that may be in place on the CP.

One inband management interface can be configured per GbE port to provide redundancy. This allows the management station on the WAN side of the network to have multiple addresses for reaching that switch and provides redundancy if one of the GbE ports cannot be reached. Communication is handled through external addresses configured independently for each inband management interface.

The following functions are not supported by the inband management interface:

- Downloading firmware
- IPv6 addressing

IP routing

The inband management interfaces are separate from the existing IP interfaces currently used for FCIP. These interfaces exist on the CP and are added and maintained on the CP routing table to ensure end-to-end connectivity. Because this routing table will be shared among all devices on the CP, including the management interface, precautions must be taken to ensure that proper connectivity is maintained. To ensure proper handling of routes, the inband management devices should be configured on a different network from the management interface and from every other inband management interface.

Inband management interface addresses must also be unique and cannot be duplicates of any addresses defined on the GbE ports. An inband management address can exist on the same network as an address defined on one of the GbE ports because the inband management interfaces use the CP routing table and not the routing table normally used for the GbE ports.

Configuring IP addresses and routes

Configure and view IP addresses and routes for Inband Management interfaces by using the following Fabric OS commands:

- `portcfg mgmtif [<slot>/]<gePort> [create | delete] <ipAddress> <netmask> [<mtu>]`
- `portcfg mgmtif [<slot>/]<gePort> [enable | disable]`
- `portshow mgmtif [<slot>/]<gePort>`
- `portcfg mgmtroute [<slot>/]<gePort> [create | delete] <destination> <netmask> <gateway>`

The following examples are configured using these commands.

Management station on the same subnet example

Figure 19 shows an example of configuring inband management with the management station attached to the same subnet as managed switches. Note that only the IP address is required for each extension switch.

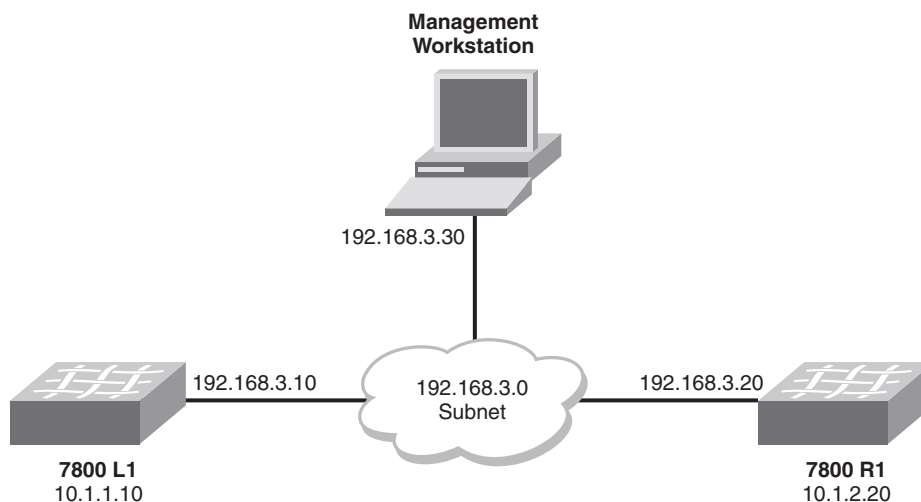

FIGURE 19 Management station configured on the same subnet

7800 L1

Configure the inband management interfaces.

```
portcfg mgmtif ge0 create 192.168.3.10 255.255.255.0
```

7800 R1

Configure the inband management interfaces.

```
portcfg mgmtif ge0 create 192.168.3.20 255.255.255.0
```

Management station

Access the Brocade 7800 switches through the external inband management station.

```
telnet 192.168.3.10
```

Management station on a different subnet example

The example configuration in [Figure 20](#) consists of the switches and the management station on different networks and attached through a WAN cloud. The routers are assumed to already have route entries to access each other subnet.

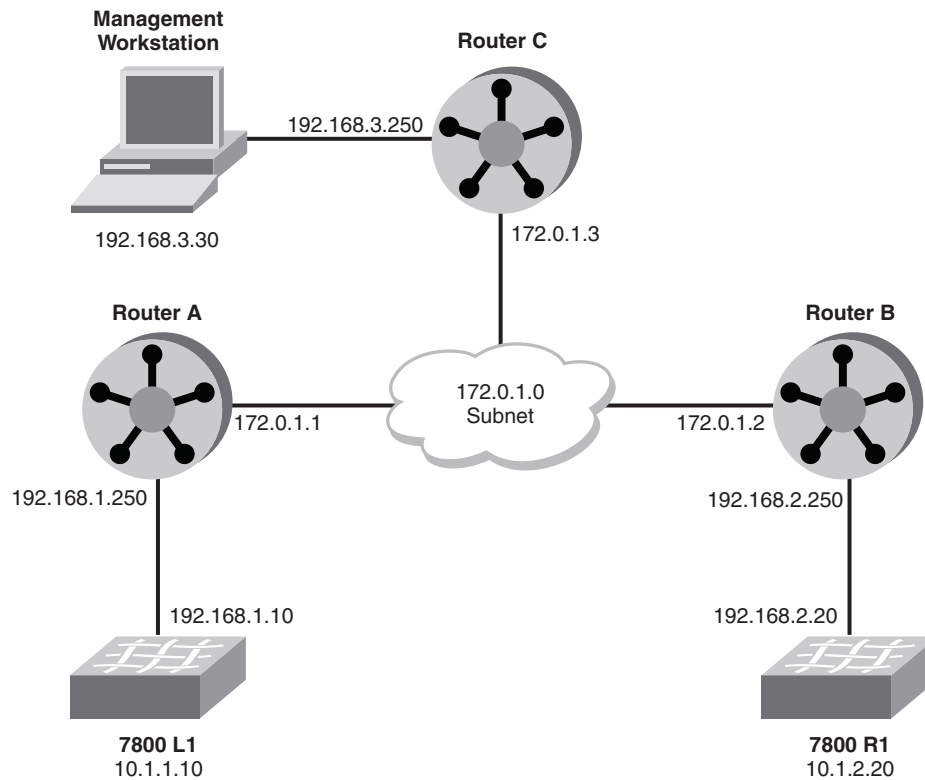

FIGURE 20 Management station configured on different subnets

4 Inband management

7800 L1

1. Configure the inband management interfaces.

```
portcfg mgmtif ge0 create 192.168.1.10 255.255.255.0
```

2. Configure the inband management route for the management station.

```
portcfg mgmtroute ge0 create 192.168.3.0 255.255.255.0 192.168.1.250
```

7800 R1

1. Configure the inband management interfaces.

```
portcfg mgmtif ge0 create 192.168.2.20 255.255.255.0
```

2. Configure the inband management route for the management station.

```
portcfg mgmtroute ge0 create 192.168.3.0 255.255.255.0 192.168.2.250
```

Management station

1. Add route entries to access the 7800 external inband management interfaces.

```
route add 192.168.1.0 netmask 255.255.255.0 gw 192.168.3.250  
route add 192.168.2.0 netmask 255.255.255.0 gw 192.168.3.250
```

2. Access the 7800 switches through the external inband management interfaces.

```
telnet 192.168.1.10
```

Redundant connections to the management stations example

[Figure 21](#) on page 77 is an example of a redundant connection to the management station. Because the inband management interfaces do not support a multi-homing stack, unique addresses must be used on the management station to communicate with different inband management interfaces. If both management station interfaces are on the same subnet, then host-specific routes must be added on the 7800 switches.

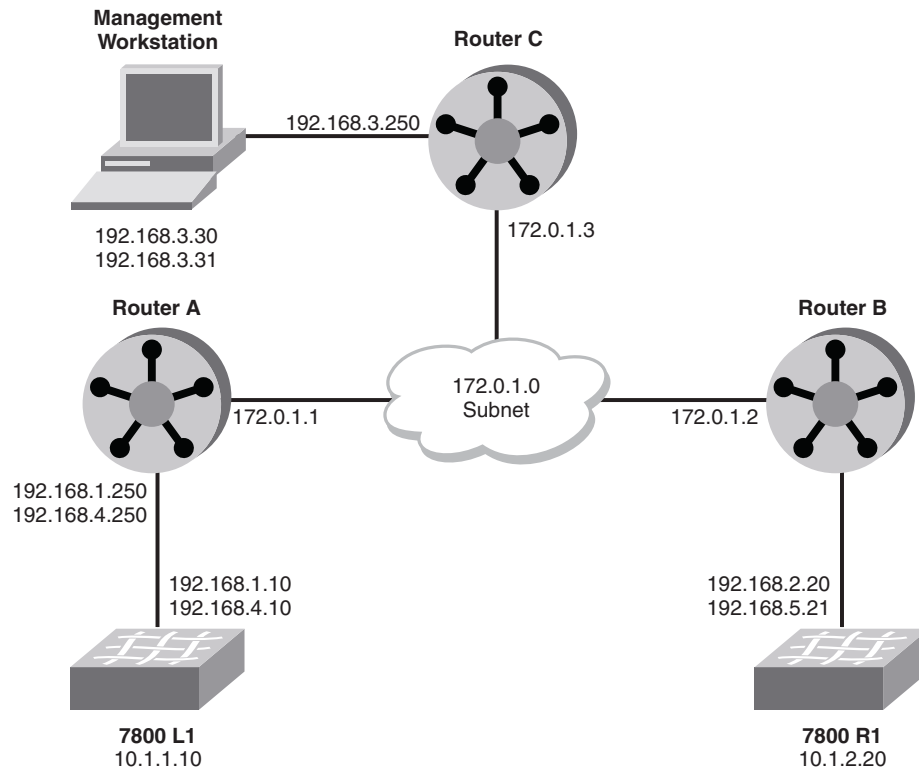

FIGURE 21 Redundant connection to management station

7800 L1

1. Configure the inband management interfaces.

```
portcfg mgmtif ge0 create 192.168.1.10 255.255.255.0
portcfg mgmtif ge1 create 192.168.4.10 255.255.255.0
```

2. Configure the inband management route for the management station.

```
portcfg mgmtroute ge0 create 192.168.3.30 255.255.255.255 192.168.1.250
portcfg mgmtroute ge1 create 192.168.3.31 255.255.255.255 192.168.4.250
```

7800 R1

1. Configure the inband management interfaces.

```
portcfg mgmtif ge0 create 192.168.2.20 255.255.255.0
portcfg mgmtif ge1 create 192.168.5.20 255.255.255.0
```

2. Configure the inband management route for the management station.

```
portcfg mgmtroute ge0 create 192.168.3.30 255.255.255.255 192.168.2.250
portcfg mgmtroute ge1 create 192.168.3.31 255.255.255.255 192.168.5.250
```

Management station

1. Add route entries to get to the 7800 external inband management interfaces.

```
route add 192.168.1.0 netmask 255.255.255.0 gw 192.168.3.250
route add 192.168.2.0 netmask 255.255.255.0 gw 192.168.3.250
route add 192.168.4.0 netmask 255.255.255.0 gw 192.168.3.250
route add 192.168.5.0 netmask 255.255.255.0 gw 192.168.3.250
```

4 Inband management

2. Access the 7800 switches through the external inband management interfaces.

```
telnet 192.168.1.10
```

VLAN tagging support

To add VLAN tag entries to the VLAN tag table for inband management interfaces, use the `-mgmt` or `-m` option with the `portcfg vlantag` command. Complete the following steps:

1. Configure an IP addresses and route for an Inband Management interface using the following command format.

```
portcfg mgmtif [<slot>/]<gePort> [create|delete] <ipAddress> <netmask> <mtu>
```

2. Add the VLAN tag entry for the management interface using the following command format.

```
portcfg vlantag [<slot>/]<gePort>[add|delete] <ipAddress> <vlan_id> <L2COS>  
--mgmt
```

IP forwarding support

IP forwarding is supported over inband management to allow communication to the remote switch through the WAN connection. This is done by enabling IP forwarding to allow IP packets arriving at the CP interface to be forwarded through the inband management interface to the remote side. To prevent network routing and actual bridging of the LAN side of the network to the WAN side of the network, the `ipfilter` command's forwarding rules will default to deny any forwarding traffic. To allow forwarding, new `ipfilter` command rules must be added to specific destinations. This will prevent any unintended network traffic from being forwarded from the LAN side to the WAN side of the network. Refer to "Using ipfilter" on page 79.

Figure 22 shows an example network where the management station is located on the LAN side of 7800 L1. Using inband management, the station can also communicate with 7800 R1.

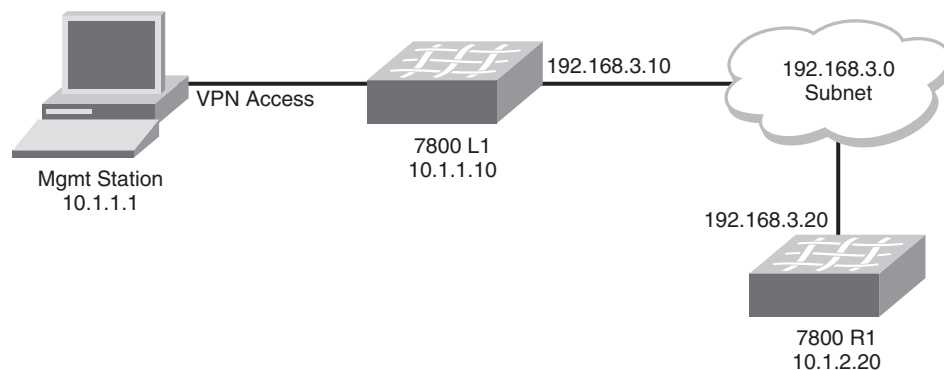

FIGURE 22 Inband management with IPv4 forwarding

For this example, you must configure the following:

- On the management station:
 - IP address 10.1.1.1/24 (defined)
 - IP route to 192.168.3.20/32 via 10.1.1.10
- On the 7800 L1:
 - CP Management address 10.1.1.10/24
 - Inband management address 192.168.3.10/24
 - IP filter forward rule with destination IP address 192.168.3.20
- On the 7800 R1:
 - CP Management address 10.1.2.20/24
 - Inband management address 192.168.3.20/24
 - Inband management route to 10.1.1.1/32 via 192.168.3.10

Once all of these configurations are complete, proper IP connectivity should occur through the network. In the case where there are routed networks between the 7800 switches, you will need to add inband management routes to each 7800 switch. Using host-specific routes will help eliminate undesired traffic. If network routes are needed, they can be substituted, but you should note that this will allow anything on that network to be forwarded, which could result in undesired disruption of FCIP traffic.

NOTE

In all routed network cases, all intermediate hops must have route entries to get to the endpoints.

Using ipfilter

Use the **ipfilter** command to create and manage forwarding rules for use with inband management. For full details on this command, options, and arguments, refer to the **ipfilter** section of the *Fabric OS Command Reference Manual*.

To create an IP forwarding rule, you must first create a new policy if one has not yet been created. The easiest way to do this is with the `--clone` option to create a copy of the default policy.

```
ipfilter --clone inband_ipv4 -from default_ipv4
```

A new rule can be added to allow forwarding traffic.

```
ipfilter --addrule inband_ipv4 -rule <rule_number> -dp <dest_port> -proto
<protocol> -act <permit|deny> -type FWD -dip <destination_IP>
```

Valid `dest_port` values are any TCP or UDP port numbers or a range of port numbers that you want forwarded. Valid `protocol` values are **tcp** or **udp**. The `destination_IP` is the IP address of the inband management interface on the remote side. After a rule is added, save the policy and activate it using the `--save` and `--activate` options. There can only be a single IPv4 policy active at any time. Each policy can consist of multiple rules.

WAN performance analysis tools

WAN analysis tools are designed to test connections, trace routes, and estimate the end-to-end IP path performance characteristics between a pair of Brocade FCIP port endpoints. These tools are available as options on the **portCmd** command. The following options are available:

- **portCmd --Tperf**—Used only with the 7800 switch and FX8-24 blade, tperf is a tunnel test tool that generates and sends test data over an FCIP tunnel to determine the characteristics and reliability of the IP network used by the tunnel at the FCIP circuit level.
- **portCmd --ipperf**—Used only with the FR4-18i blade, ipperf is used to analyze end-to-end IP path performance between a pair of FCIP ports.
- **portCmd --ping**—Tests connections between a local Ethernet port and a destination IP address.
- **portCmd --traceroute**—Traces routes from a local Ethernet port to a destination IP address.
- **portShow fcipTunnel -perf**—Displays performance statistics generated from the WAN analysis.

The tperf option

NOTE

The **Tperf** option is for 7800 switches and FX8-24 blades.

Tperf operates with a pair of 7800 switches or FX8-24 blades. One switch or blade plays the role of a data sink and the other switch or blade plays the role of the data source.

To use **Tperf**, you must first create an FCIP tunnel with at least one circuit or modify an existing tunnel using the **Tperf** flag **-T**. As with any FCIP tunnel, this must be done on both switches. The following commands create a **Tperf**-enabled tunnel with a committed rate of 10000.

```
portcfg fcipunnel 16 create 192.168.10.1 192.168.10.2 10000 -T
```

```
portcfg fcipunnel 16 create 192.168.10.2 192.168.10.1 10000 -T
```

Tperf will test single and multiple circuit tunnels. **Tperf** also tests the different priority connections that are provided by an FCIP Tunnel. When a **Tperf**-enabled tunnel is operative, it is not an active VE_Port. Fabrics will not merge over an operative FCIP **Tperf** tunnel. To determine if the **Tperf** tunnel is up, issue the following command:

```
switch:admin> portshow fcipunnel all -c
```

Tunnel	Circuit	OpStatus	Flags	Uptime	TxMBps	RxMBps	ConnCnt	CommRt	Met
16	-	Up	----T--	1h21m43s	0.00	0.00	2	-	-
16	0 ge0	Up	---4--s	1h21m34s	0.00	0.00	2	500/500	0
16	1 ge1	Up	---4--s	1h21m43s	0.00	0.00	2	500/500	0

```
Flags: tunnel: c=compression m=moderate compression a=aggressive compression
A=Auto compression f=fastwrite t=Tapepipelining F=FICON
T=TPerf i=IPSec l=IPSec Legacy
Flags: circuit: s=sack v=VLAN Tagged x=crossport 4=IPv4 6=IPv6 T=Test(CPerf)
L=Listener I=Initiator
```

The previous display shows VE_Port 16 as up, but a **switchshow** command for that same VE_Port will show the following:

```
switch:admin> switchshow | grep 16
 16 16 631000 -- -- Offline VE
```

The **Tperf** command determines the path characteristics to a remote host or tunnel destination. The syntax is as follows:

portcmd -tperf [slot/] <VE_port number> -sink | -source [-high | -medium | -low][-time duration] [-unidirectional] [-random] [-pattern pattern] [-size pdu_size] [-interval interval]

For full details on syntax and using this command, refer to the *Fabric OS Command Reference Manual*.

The following examples create a **Tperf** data sink and a **Tperf** data source on VE_Port 16.

```
switch:admin> portcmd --tperf 16 -sink -interval 15
switch:admin> portcmd --tperf 16 -source -interval 15 -high -medium -low
```

For details on this command, syntax, and output examples, refer to the *Fabric OS Command Reference Manual*.

Tperf generates statistics every 30 seconds by default unless you specify a different value for **-interval**. [Table 14](#) briefly describes the output.

TABLE 14 Tperf output

Item	Description
Tunnel ID	Numeric identifier for the TPerf tunnel.
Traffic	Priority High, Medium, or Low.
bytes tx	Number of bytes transmitted.
bytes rx	Number of bytes received.
PDU's tx	Number of protocol data units transmitted.
PDU's rx	Number of protocol data units received.
bad CRC headers rx	Number of bad CRC headers received.
bad CRC payloads rx	Number of bad CRC payloads received.
out of seq PDU's rx	Number of out-of-sequence PDU's received.
flow control count	Flow control count.
packet loss (%)	The percentage of packet loss.
bytes/second	The number of bytes transmitted per second.
last rtt	The time it took for the last round-trip between the Tperf source and the Tperf sink in milliseconds. This is calculated only on the source side report. It is reported as N/A on the sink side report.

The ipperf option

NOTE

The **ipperf** option is for FR4-18i blades. It does not work with 7800 switches and FX8-24 blades.

The **ipperf** option allows you to specify the slot and port information for displaying performance statistics for a pair of ports. For this basic configuration, you can specify the IP addresses of the endpoints, target bandwidth for the path, and optional parameters such as the length of time to run the test and statistic polling interval.

Only a single **ipperf** session can be active on an FCIP GbE port at any time. Each FCIP port supports a single instance of the WAN tool-embedded client running in only sender or receiver mode. You can, however, use multiple CLI sessions to invoke simultaneous **ipperf** sessions on different FCIP ports.

The **ipperf** sessions use different TCP ports than FCIP tunnels, so you can simultaneously run an **ipperf** session between a pair of ports while an FCIP tunnel is online. You can, for example, revalidate the service provider Service Level Agreement (SLA) without bringing the FCIP tunnel down, but the general recommendation is to run **ipperf** only when there are no active tunnels on the IP network. Data transferred across an active FCIP tunnel competes for the same network bandwidth as the **ipperf** session, and **ipperf** is attempting to saturate a network to determine how much usable bandwidth is available between the sites. Unless you have a method to quiesce all storage traffic over an active FCIP tunnel during **ipperf** testing, you may experience undesirable interactions.

Allocation of the FCIP GbE port bandwidth behaves exactly the same for **ipperf** as for FCIP tunnels. If bandwidth is allocated for FCIP tunnels, the **ipperf** session uses the remaining bandwidth. Because bandwidth is already reserved for the FCIP tunnels, the **ipperf** session is not affected by any active FCIP tunnel. If no bandwidth is reserved, the **ipperf** session competes for a share of the uncommitted bandwidth. Starting an **ipperf** session has an impact on any active uncommitted bandwidth FCIP tunnels just like adding a new FCIP tunnel would. For example:

- Adding a committed-rate **ipperf** session reduces the total uncommitted bandwidth shared by all the uncommitted bandwidth FCIP tunnels.
- Adding an uncommitted-bandwidth **ipperf** session adds another flow competing for the shared uncommitted bandwidth.

The CLI and configuration system ensures that any bandwidth allocation does not result in an over commitment of the FCIP GbE port. An active FCIP tunnel cannot be forced to give up its committed buffer and bandwidth resources. Therefore, to commit a specific bandwidth to the **ipperf** session, you must have an equivalent amount of spare capacity on the FCIP GbE port.

Iperf performance statistics

Table 15 lists the end-to-end IP path performance statistics that you can display using the `portCmd` `iperf` command and option.

TABLE 15 WAN tool performance characteristics

Characteristic	Description
Bandwidth	Indicates the total packets and bytes sent. Bytes/second estimates are maintained as a weighted average with a 30 second sampling frequency and also as an average rate over the entire test run. The CLI output prints the bandwidth observed in the last display interval as well as the Weighted Bandwidth (WBW). BW represents what the FCIP tunnel / FC application sees for throughput rather than the Ethernet on-the-wire bytes.
Loss	Indicates the loss estimate is based on the number of TCP retransmits (assumption is that the number of spurious retransmits is minimal). Loss rate (percentage) is calculated based on the rate of retransmissions within the last display interval.
Delay	Indicates TCP smoothed RTT and variance estimate in milliseconds.
Path MTU (PMTU)	Indicates the largest IP-layer datagram that can be transmitted over the end-to-end path without fragmentation. This value is measured in bytes and includes the IP header and payload. There is a limited support for black hole PMTU discovery. If the Jumbo PMTU (anything over 1500) does not work, iperf will try 1260 bytes (minimum PMTU supported for FCIP tunnels). If 1260 PMTU fails, iperf will give up. There is no support for aging. PMTU detection is not supported for active tunnels. During black hole PMTU discovery, the BW, Loss, and PMTU values printed may not be accurate.

Starting an iperf session

Typically, you start the WAN tool before setting up a new FCIP tunnel between two sites. You can configure and use the `--iperf` option immediately after installing the IP configuration on the FCIP port (for example, IP address, route entries). Once the basic IP addressing and IP connectivity is established between two sites, you can configure `--iperf` with parameters similar to what will be used when the FCIP tunnel is configured.

The traffic stream generated by the WAN tool iperf session can be used for the following functions:

- Validate a service provider Service Level Agreement (SLA) throughput, loss, and delay characteristics.
- Validate end-to-end PMTU, especially if you are trying to eliminate TCP segmentation of large Fibre Channel (FC) frames.
- Study the effects and impact FCIP tunnel traffic may have on any other applications sharing network resources.

To start an `--iperf` session, you can use any port as long as the port (in combination with local interface) is not in use. You must run the `--iperf` client on both the host (source mode, `-S` option) and receiver (sink mode, `-R` option). See “Iperf options” on page 84 for more information about specifying source and sink mode.

1. Configure the receiver test endpoint using the CP CLI.

The syntax for invoking the receiver test endpoint using `--iperf` for slot8, port ge0 on an FR4-18i is as follows:

```
portcmd --iperf 8/ge0 -s 192.168.255.10 -d 192.168.255.100 -R
```

2. Configure the sender test endpoint using a similar CP CLI.

The syntax for invoking the sender test endpoint using `--ipperf` for slot8, port ge0 on an FR4-18i is as follows:

```
portcmd --ipperf 8/ge0 -s 192.168.255.100 -d 192.168.255.10 -s
```

For details of `portcmd --ipperf` syntax and output examples, refer to the *Fabric OS Command Reference Manual*.

Ipperf options

General syntax of the `portcmd --ipperf` command is as follows:

```
portCmd --ipperf [slot]/ge0|ge1 -s source_ip -d destination_ip -S|-R [-r rate] [-z size] [-t time]
[-i interval] [-p port] [-q diffserv] [-v vlan_id] [-c L2_Cos]
```

For details of command syntax and output examples, refer to the *Fabric OS Command Reference Manual*.

Using ping to test a connection

The `portCmd --ping` command tests the connection between the IP address of a local Ethernet port and a destination IP address. If you want to use this command to test a VLAN connection when you do not have an active FCIP tunnel, you must manually add entries to the VLAN tag table on both the local and remote sides of the route, using `portCfg vlantag` command.

General syntax of the `portcmd --ping` command are as follows:

```
portCmd --ping [slot]/ge<n>|xge<n> -s source_ip -d destination_ip [-n num_requests] [-q diffserv]
[-t ttl] [-w wait_time] [-z size] [-v vlan_id] [-c L2_Cos]
```

For details of command syntax and output examples, refer to the *Fabric OS Command Reference Manual*.

Using traceroute

The `portCmd traceroute` command traces routes from a local Ethernet port to a destination IP address. If you want to use this command to trace a route across a VLAN when you do not have an active FCIP tunnel, you must manually add entries to the VLAN tag table on both the local and remote sides of the route using `portCfg vlantag` command.

General syntax of the `portcmd --traceroute` command are as follows.

```
portCmd --traceroute [slot]/ge<n>|xge<n> -s source_ip -d destination_ip [-h max_hops] [-f
first_ttl] [-q diffserv] [-w wait time] [-z size] [-v vlan_id] [-c L2_Cos]
```

The following example traces the route between IP addresses 192.168.10.1 and 192.168.20.1 over VLAN 10.

```
portcmd --traceroute 8/ge0 -s 192.168.10.1 -d 192.168.20.1 -v 10
```

NOTE

To trace a route with crossport addresses, refer to [“Using traceroute with crossports”](#) on page 15.

For details of command syntax and output examples, refer to the *Fabric OS Command Reference Manual*.

Portshow command usage

Use the **portshow** command to display operational information for Brocade 7800 switches, Brocade FX8-24 blades, and Brocade FR4-18i blades. The *Fabric OS Command Reference Manual* provides complete descriptions of **portshow** command syntax and options. The following sections identify a few specific outputs that may be useful for maintenance and troubleshooting.

Displaying IP interfaces

The following example displays IP interface information for a 7800 switch.

```
switch:admin> portshow ipif ge0
```

For details of command syntax and output examples, refer to the *Fabric OS Command Reference Manual*.

Displaying IP routes

The following example displays IP route information for a 7800 switch.

```
switch:admin> portshow iproute ge5
```

For details of command syntax and output examples, refer to the *Fabric OS Command Reference Manual*.

Displaying FCIP tunnel information

The following example of the **portshow fciptunnel** command is used most often to determine FCIP tunnel status.

```
switch:admin> portshow fciptunnel all -c
```

For details of command syntax and output examples, refer to the *Fabric OS Command Reference Manual*.

Displaying IP addresses

You can display IP addresses configured for specific circuits using the **ip-address** option with the **circuit** option as in the following example.

```
switch:admin> portshow fciptunnel all --circuit --ip-address
```

For details of command syntax and output examples, refer to the *Fabric OS Command Reference Manual*.

Displaying performance statistics

Display a summary of performance statistics for tunnels and circuits using the **circuit**, **perf**, and **summary** options as in the following example.

```
switch:admin> portshow fciptunnel all --circuit --perf --summary
```

For details of command syntax and output examples, refer to the *Fabric OS Command Reference Manual*.

Displaying QoS statistics

Display QoS statistics for tunnels using the **qos** and **summary** options as in the following example. For details of command syntax and output examples, refer to the *Fabric OS Command Reference Manual*.

```
switch:admin> portshow fciptunnel all --qos --summary
```

For details of command syntax and output examples, refer to the *Fabric OS Command Reference Manual*.

Displaying details

You can display configuration details using the **detail** option with the **all** option as in the following example.

```
switch:admin> portshow fciptunnel all --detail
```

For details of command syntax and output examples, refer to the *Fabric OS Command Reference Manual*.

Displaying FCIP tunnel information (7800 switch and FX8-24 blade)

The following example will display general tunnel information for a 7800 switch.

```
switch:admin> portshow fciptunnel 16
```

For details of command syntax and output examples, refer to the *Fabric OS Command Reference Manual*.

Displaying an FCIP tunnel with FCIP circuit information (7800 switch and FX8-24 blade)

The following example adds circuit information to the **fciptunnel** output using the **-c** option.

```
switch:admin> portshow fciptunnel 17 -c
```

For details of command syntax and output examples, refer to the *Fabric OS Command Reference Manual*.

Displaying FCIP tunnel performance (7800 switch and FX8-24 blade)

The following example will display performance statistics for a tunnel on a 7800 switch.

```
switch:admin> portshow fciptunnel 17 --perf
```

For details of command syntax and output examples, refer to the *Fabric OS Command Reference Manual*.

Displaying FCIP tunnel TCP connections (7800 switch and FX8-24 blade)

The following example will display TCP connections for a tunnel on a 7800 switch.

```
switch:admin>portshow fciptunnel 17 -c --tcp
```

For details of command syntax and output examples, refer to the *Fabric OS Command Reference Manual*.

Displaying FCIP circuits (7800 switch and FX8-24 blade)

The following example will display all FCIP circuit information for an a7800 switch or FX8-24 blade.

```
switch:admin> portshow fcipcircuit all
```

For details of command syntax and output examples, refer to the *Fabric OS Command Reference Manual*.

Displaying a single circuit

The following example will display information for a 7800 switch.

```
switch:admin> portshow fcipcircuit 20 1
```

For details of command syntax and output examples, refer to the *Fabric OS Command Reference Manual*.

Displaying FCIP circuit performance (7800 switch and FX8-24 blade)

The following example will display FCIP circuit performance information for a 7800 switch.

```
switch:admin> portshow fcipcircuit 20 1 --perf
```

For details of command syntax and output examples, refer to the *Fabric OS Command Reference Manual*.

Displaying QoS prioritization for a circuit

The following example will display QoS prioritization for an FCIP circuit on a 7800 switch.

```
switch:admin> portshow fcipcircuit 20 1 --perf --qos
```

For details of command syntax and output examples, refer to the *Fabric OS Command Reference Manual*.

Displaying FCIP tunnel information (FR4-18i blade)

You can use the **portShow fcipTunnel** command to view the performance statistics and monitor the behavior of an online FCIP tunnel. To view detailed **fcipTunnel** statistics, you must specify either the **-perf** or **-params** options. The command syntax is as follows.

```
portShow fciptunnel [slot]/ge0|ge1 all|tunnel ID -perf -params
```

The following example shows the **portCmd fcipTunnel** with the **-perf** option to display performance characteristics of tunnel 0.

```
switch:admin06> portshow fciptunnel 8/ge0 all -perf
```

For details of command syntax and output examples, refer to the *Fabric OS Command Reference Manual*.

The following example shows the **portCmd fcipTunnel** with the **parameters** options to display the parameters of tunnel 0:

```
switch:admin06> portshow fciptunnel 8/ge0 0 -params
```

For details of command syntax and output examples, refer to the *Fabric OS Command Reference Manual*.

FCIP tunnel issues

The following are common FCIP tunnel issues and recommended actions for you to follow to fix the issue.

NOTE

The **portshow -perf** and **-params** options can be applied only to the FR4-18i blade.

Symptom *FCIP tunnel does not come Online.*

Probable cause and recommended action

Confirm the following steps.

1. Confirm GE port is online.

```
portshow ge1
Eth Mac Address: 00.05.1e.37.93.06
Port State: 1 Online
Port Phys: 6 In_Sync
Port Flags: 0x3 PRESENT ACTIVE
Port Speed: 1G
```

2. Confirm IP configuration is correct on both tunnel endpoints using the following command.

```
portshow ipif gel
```

3. Enter the **portCmd --ping** command to the remote tunnel endpoint from both endpoints.

The -s value is the source IP address; the -d value is the destination IP address.

```
portcmd --ping gel -s 11.1.1.1 -d 11.1.1.2
```

If the command is successful, then you have IP connectivity and your tunnel should come up. If not continue to the next step.

4. Enter the **portCmd --traceroute** command to the remote tunnel endpoint from both endpoints.

```
portcmd --traceroute gel -s 11.1.1.1 -d 11.1.1.2
```

5. The tunnel or route lookup may fail to come online because of a missing but required IP route. If there are routed IP connections that provide for the FCIP tunnel, then both ends of the tunnel must have defined ipRoute entries.

Refer to the [“Configuring an IP route”](#) on page 37 to review the setup of the IP route.

6. Confirm FCIP tunnel is configured correctly using the following command:

```
portshow fciptunnel gel all
```

The Compression, Fastwrite, and Tape Pipelining settings must match the opposite endpoint or the tunnel may not come up. Remote and local IP and WWN should be opposite each other.

For details on command syntax and example output, refer to the *Fabric OS Command Reference Manual*.

7. Get a GE Ethernet sniffer trace.

Rule out all possible blocking factors. Routers and firewalls that are in the data path must be configured to pass FCIP traffic (TCP port 3225) and IPsec traffic, if IPsec is used (UDP port 500). If possible blocking factors have been rule out, simulate a connection attempt using the **portCmd --ping** command, from source to destination, and then take an Ethernet trace between the two endpoints. The Ethernet trace can be examined to further troubleshoot the FCIP connectivity.

Symptom *FCIP tunnel goes online and offline.*

Probable cause and recommended action

A bouncing tunnel is one of the most common problems. This issue is usually because of an over commitment of available bandwidth resulting in the following behaviors.

- Too much data tries to go over the link.
- Management data gets lost, queued too long, and timeouts expire.
- Data exceeds timeouts multiple times.

Take the following steps gather information.

1. Verify what link bandwidth is available.
2. Confirm the IP path is being used exclusively for FCIP traffic.

3. Confirm that traffic shaping is configured to limit the bandwidth to available using one of the following commands:

- **portShow fciptunnel all -perf -params** (FR4-18i blade)
- **portShow fciptunnel all -perf -tcp -c** (7800 switch and FX8-24 blade)

Examine data from both routers. This data shows retransmissions indicating input and output rates on the tunnels.

Gather this information for both data and management TCP connections.

4. Run **Tperf** for 7800 switches and FX8-24 blades, or **ipperf** for FR4-18i blades to gather WAN performance data.

FCIP links

The following list contains information for troubleshooting FCIP links:

- When deleting FCIP links, you must delete them in the exact reverse order they were created. That is, first delete the tunnels, then the IP interfaces, and finally the port configuration. Statically defined IP routes are not removed automatically and must be removed before manually before deleting IP addresses.
- IP addresses and FCIP configurations are retained by slot in the system. If FR4-18i blades are moved to different slots without first deleting configurations, errors can be seen when trying to reuse these IP addresses.
- The **portCmd --ping** command only verifies physical connectivity. This command does not verify that you have configured the ports correctly for FCIP tunnels.
- Ports at both ends of the tunnel must be configured correctly for an FCIP tunnel to work correctly. These ports can be either VE_Ports or VEX_Ports. A VEX_Port must be connected to a VE_Port.
- When configuring routing over an FCIP link for a fabric, the edge fabric will use VE_Ports and the backbone fabric will use VEX_Ports for a single tunnel.
- If an FCIP tunnel fails with the “Disabled (Fabric ID Oversubscribed)” message, the solution is to reconfigure the VEX_Port to the same Fabric ID as all of the other ports connecting to the edge fabric.
- Because of an IPsec RASLog limitation, you may not be able to determine an incorrect configuration that causes an IPsec tunnel to not become active. This misconfiguration can occur on either end of the tunnel. As a result, you must correctly match the encryption method, authentication algorithm, and other configurations on each end of the tunnel.

Gathering additional information

The following commands should be executed and their data collected before the **supportsave** command is run. A **supportsave** can take ten minutes or more to run, and some of the information is time critical.

NOTE

The **portshow -perf** and **-params** options can be applied only to the FR4-18i blade.

- **traceDump -n**

- **portTrace –show all**
- **portTrace –status**

For issue specific to tunnel ports, run and collect the data from the following commands:

- **slotShow**
- **portShow** [*slot number/*]*<geport number>*

If possible, run and collect the data from the following commands:

- **portShow ipif all** [*slot number/*]*<geport number>*
Displays IP interface configuration for each GbE port (IP address, gateway and MTU)
- **portShow arp all** [*slot number/*]*<geport number>*
- **portShow iproute all** [*slot number/*]*<geport number>*
- **portShow fciptunnel** [*slot number/*]*<geport number>* *<all | tunnel ID>*
Displays complete configuration of one or all of the FCIP tunnels
- **portShow fciptunnel -all -params** (FR4-18i only)
- **portShow fciptunnel -all -perf** (FR4-18i only)
- **portShow fciptunnel -all -credits** (FR4-18i only)
- **portShow fciptunnel all -c** (7800 and FX8-24 only)
- **portShow fciptunnel all –circuit –perf –summary** (7800 and FX8-24 only)
- **portShow fciptunnel all –circuit –perf –tcp –qos** (7800 and FX8-24 only)
- **portCmd** *<–ping | –traceroute | –perf >*
- Ping and traceroute utility
- Performance to determine path characteristics between FCIP endpoints

And finally gather the data from the **supportSave -n** command.

Refer to the *Fabric OS Administrator's Guide* or *Fabric OS Command Reference Manual* for complete details on these commands.

FTRACE concepts

FTRACE is a support tool used primarily by your switch support provider. FTRACE can be used in a manner similar to that of a channel protocol analyzer. FTRACE may be used to troubleshoot problems using a Telnet session rather than sending an analyzer or technical support personnel to the site.



CAUTION

FTRACE is meant to be used solely as a support tool and should be used only by Brocade support personnel, or at the request of Brocade support personnel.

For the 7800 switch and the FX8-24 blade, FTRACE is always enabled, and the trace data is automatically captured.

4 FTRACE concepts

For the FR4-18i blade, FTRACE must be manually configured and enabled using the appropriate Fabric OS command. Root access is required.

Index

Numerics

- 10GbE lossless failover, 18
- 7800 switch, 6
 - configuring a GbE port, 36
 - configuring an IP route, 37
 - creating and FCIP circuit, 44

A

- Adaptive Rate Limiting (ARL), 21

B

- backend bandwidth, 12
- bandwidth
 - backend, 12
 - frontend, 13

C

- configuring IP routes for crossport addresses, 14
- creating a multicircuit FCIP tunnel, 46
- creating an FCIP tunnel, 38
- crossport
 - active-active configuration, 19
 - active-passive configuration, 19
 - configuring, 13
 - configuring IP routes, 14
 - configuring VLAN tags, 14
 - defined, 13
 - using ping, 14
 - using traceroute, 15

E

- extended interswitch link (XISL), 35

F

- failover in TI zones, 20
- FCIP
 - configuration guidelines, 66
 - configuring VEX_Ports, 34, 67
 - creating a tunnel, 69
 - creating interfaces, 67
 - creating routes, 67
 - DSCP, 24
 - gathering additional information, 90
 - IP compression, 58
 - IPsec changeable parameters, 60
 - IPsec configuration, 59
 - IPsec fixed parameters, 60
 - IPsec implementation, 58
 - L2CoS, 24
 - modifying a tunnel, 70
 - modifying QoS, 71
 - persistently disabled ports, 34, 45, 67, 70
 - QoS implementation, 24
 - testing a connection, 84
 - tracing a route, 84
 - tunnel bounces, 89
 - tunnel does not come online, 88
 - tunneling, 3
 - VE_Ports, 56
 - verifying the tunnel, 45, 69
 - VEX_Ports, 56
 - Virtual Fabrics, 62
 - VLAN tags, 26
- FCIP Design Considerations, 55
 - 7800 switch and FX8-24 blade, 33
- FCIP Fastwrite, 63
- FCIP information, 90
- FCIP trunking, 15
- FCIP trunking capacity on the FX8-24 blade, 11
- FCIP tunnel
 - creating, 38
 - example multicircuit configuration, 46
- FCIP tunnels and VE_Ports on the 7800 switch, 8
- FCIP tunnels and VE_Ports on the FX8-24 blade, 10
- Fibre Channel over IP, 3

FR4-18i blade, 55
frontend bandwidth, 13
FSPF link cost calculation when ARL is used, 21
FTRACE, configuring, 91
FX8-24 blade, 8
 removal, 10

G

GbE port mode on the FX8-24 blade, 35

I

inband management, 73
 configuring IP addresses and routes, 74
 IP routing and subnets, 74
 VLAN tagging support, 78
iperf, 82
IPsec
 FCIP, 58
 FCIP changeable parameters, 60
 FCIP configuration, 59
 FCIP fixed parameters, 60
 limitations for 7800 and FX8-24, 29
 limitations for FR4-18i, 59
 NAT limitation for 7800 and FX8-24, 29
 NAT limitation for FR4-18i, 59

L

License requirements
 7800 switch, 7
 FX8-24 blade, 10
Load leveling and failover, 17
lossless failover, 18

M

Media type for 7800 GbE ports, 35
moving ports in logical switches, 51

N

NAT limitation for IPsec (7800 and FX8-24), 29

NAT limitation for IPsec (FR4-18i), 59
NAT support for FR4-18i blade, 55

O

Open Systems Tape Pipelining (OSTP), 30, 63
over-subscription guidelines for tunnels, 8, 11

P

ping for crossport addresses, 14
port sharing, 51
port sharing limitations, 52

Q

QoS
 configuring priority percentages
 QoS SID/DID priorities, 21
QoS implementation in FCIP, 24
QoS priorities per FCIP circuit, 21

S

sharing GbE ports, 51

T

tperf, 80
traceroute for crossport addresses, 15
tunnel goes on- and offline, 89

V

VE_Ports, 56
VEX_Port, 56
virtual fabrics, 51
Virtual Fabrics for FCIP, 62

W

WAN, 80

WAN analysis tools, 80

X

XISL

enabling for VE ports, 35

